











Systems Reference Library

IBM System/360 System Summary

This publication provides basic information about the IBM System/360, with the objective of helping readers to achieve a general understanding of this new data processing system and the interrelationships of its models and parts. Broad system concepts, basic and optional features, and specific input/output devices are briefly discussed.

More detailed information on processing functions is in a companion publication, *IBM System/360 Principles of Operation*, Form A22-6821. Further details on the I/O devices described are in publications announced in the weekly publications release letter.

Copies of this and other IBM publications can be obtained through IBM Branch offices.
Address comments concerning the content of this publication to:
IBM Corporation, Customer Manuals, Dept. B98, P.O. Box 390, Poughkeepsie, N. Y. 12602

Contents

Introduction to the System Concepts	5	Tapes	22
System Concepts	5	IBM 2400 Series Magnetic Tape Units	22
Unified Design	5	IBM 7340 Hypertape Drive Model 3	23
Universality	6	IBM 2816 Switching Unit Model 1, 2	23
Compatibility	6	IBM 2671 Paper Tape Reader	24
Programming Systems	6	Files	24
Main Core Storage	6	IBM 1302 Disk Storage Model N1, N2	24
Storage Protection	7	IBM 2321 Data Cell Drive Model 1	24
Shared Storage	7	IBM 7320 Drum Storage	25
Large-Capacity Storage	7	IBM 2311 Disk Storage Drive	25
Arithmetic	7	IBM 2841 Storage Control Unit	27
Instructions	8	IBM 2301 Drum Storage	27
Open-Ended Design	8	Card Input/Output	29
Interruption System	8	IBM 1402 Card Read Punch Model N1	29
System Accuracy and Reliability	8	IBM 1442 Card Read Punch Model N1	29
Universal Code Capability	9	Printers	30
Channels	9	IBM 1403 Printer Model 2, 3	30
Channel Connector	11	IBM 1404 Printer Model 2	30
Flexibility in Speed, Storage, Features, and I/O	11	IBM 2201 Printer Model 3	31
Standard Connections for I/O Devices	11	IBM 2821 Control Unit Model 1, 2, 3, 4	31
Multisystem	12	IBM 1443 Printer Model N1	31
Direct Control	12	IBM 1445 Printer Model N1	31
System Panel	12	Magnetic Ink	33
1401 Compatibility	12	IBM 1412 Magnetic Character Model 1 and IBM 1419	
System Organization	13	Magnetic Character Model 1	33
Machine Addressing	13	IBM 1418 Optical Character Reader Model 1, 2, 3, and	
Formats	13	IBM 1428 Alphameric Optical Reader Model 1, 2, 3	33
Interruption and Program Status Word	13	IBM 1231 Optical Mark Page Reader Model N1	34
Control of I/O	15	Communications	35
I/O Equipment Pertaining to ASCII	15	IBM 2701 Data Adapter Unit	35
Input/Output Devices	16	IBM 2702 Transmission Control	38
Visual Output	17	Communications Systems	40
IBM 2250 Display Unit Model 1, 2	17	IBM 1030 Data Collection System	40
IBM 1015 Inquiry Display Terminal Model 1, 2	17	IBM 1050 Data Communication System	40
Manual Controls	20	IBM 1060 Data Communication System	41
IBM 1052 Printer-Keyboard Model 1	20	IBM 1070 Process Communication System	42
IBM 1051 Control Unit Model 1, N1	20	Audio Communications	42
IBM 2150 Console	20	IBM 7770 Audio Response Unit Model 3	42
		IBM 7772 Audio Response Unit Model 3	44

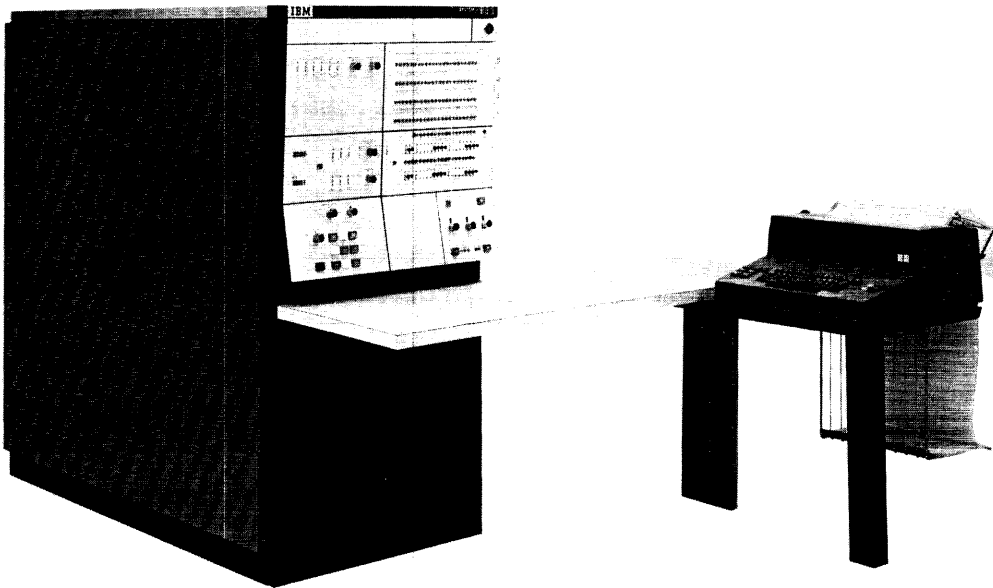

For Model 30, see Figure 3.

For Model 50, see Figure 4.

For Model 60, see Figure 5 (Model 62 differs only in core storage speed).

For Model 70, see Figures 6 and 7.

Introduction to the System Concepts

IBM System/360 is an entirely new data processing system, brought into existence to provide the comprehensive range of computing versatility required by the many modern challenges of industry and science. The models within this system are identical in concept and compatible in programming but are matched in size, speed, and cost to the various new applications and data rate demands.

The design effort for the System/360 addressed major needs that, historically, have faced the computer customer: large high-speed storage capacities; improved facilities for communications; fixed and variable-length field capabilities; and the ability to efficiently process both commercial and scientific information.

Equally as important in the basic design philosophy was the principle that the measurement of the system would not be solely in events per microsecond, but, more importantly, in answers per dollar per month.

All these objectives, and many others as significant, have been realized in the IBM System/360.

An important aid toward the accomplishment of these design objectives was a technological change, a new dimension in data processing — solid logic technology. This is the first time a commercially available

system has been built using micro-miniaturization of components and circuits. It has four direct results: greater reliability, higher speed, lower cost, and more compactness. See Figure 1.

Data throughput has been radically increased through new principles leading to more internal machine efficiency; for example, logical concepts, such as accumulators, no longer necessarily imply a type of physical structure. The engineering design for logical requirements has broken out of traditional forms and is now strictly based on cost performance.

The System/360 is generally capable of supervising itself, with little or no manual intervention for routine tasks. This is effected by the control programs, by non-stop operation, by delegation of I/O control to data channels, by a timer, by the tamperproof storage protection, and by the interruption system to be discussed.

System Concepts

Unified Design

The System/360 approach does much to organize data processing and simplify the tasks of the operator

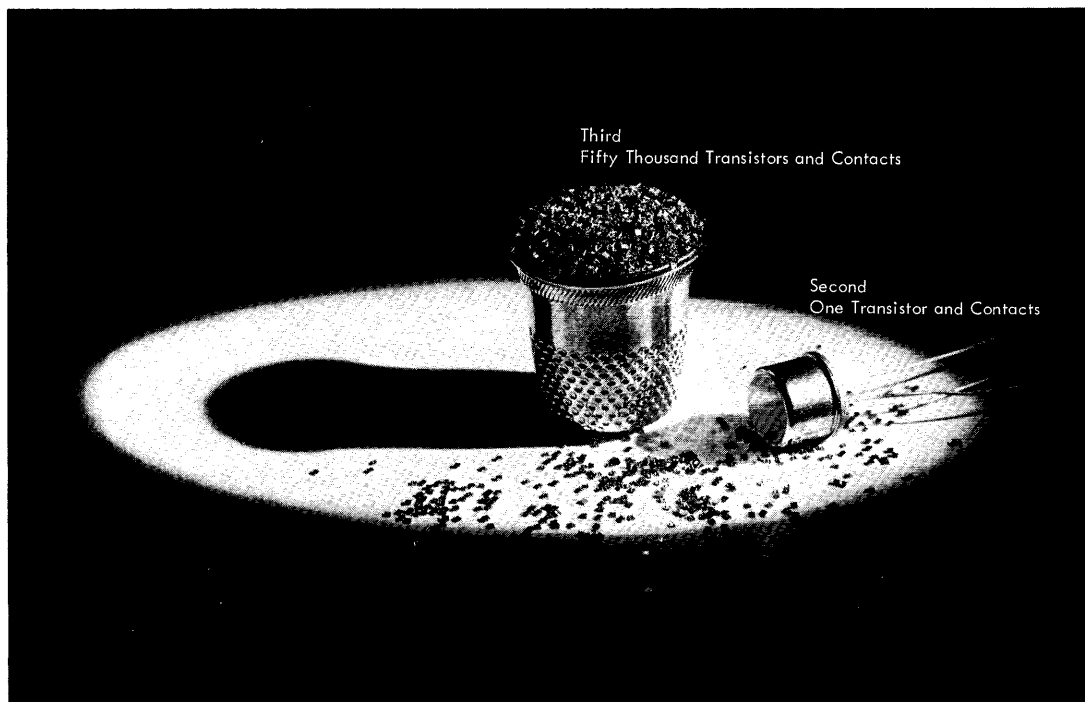

Figure 1. Second and Third Generation Components

and problem programmer. In the range of models (30, 40, 50, 60, 62, and 70), Model 70 has about 15 times the internal performance of Model 30 when used for commercial tasks, or approximately 50 times for scientific problems, with the other models performing at intermediate points. The performance points throughout this range are obtained by:

- The speed of the storage;
- The speed of the circuits;
- The amount of information moved throughout the system at one time; and
- The number of events that can take place at one time.

These differences in speed and capability for simultaneous processing greatly affect over-all performance; none affects the appearance of the design to the programmer, nor does it affect the results of any program that does not depend on time (see "Compatibility").

Universality

The System/360 is a truly general-purpose system designed to meet the needs of the commercial, scientific, communications, and control system users. It obviates the choice between a "commercial" system with its decimal arithmetic, variable-length fields, editing capabilities, etc., and a "scientific" system with its high storage utilization (because of binary format), high-speed arithmetic, etc. The System/360 combines all such features.

This means that applications presently assigned to various systems can be done by a single universal system; this is true whether the application is large or small and regardless of the type — commercial, communications, scientific, control, or mixed.

Universality has a side benefit: once the user's systems personnel have been trained in the operation of one of the System/360 models, they understand all models of the system.

Compatibility

System compatibility ensures the easy growth to a larger model, whenever the user finds that necessary, with continued utility of his programs. The facility exists at any time to use small models to back up large ones — within the limits of compatibility.

The models of the IBM System/360 are fully instruction set compatible with one another. This means that any program that operates on one model will operate on any other model that has the required configuration of equipment.

Compatibility may be lost where execution of a program depends on internal timings or the relationship between internal timings and input/output speed.

Further details concerning compatibility are given in *IBM System/360 Principles of Operation*, Form A22-6821.

Programming Systems

The System/360 was designed to operate almost entirely under control programs. Concepts such as multi-programming and program relocation are basic in the System/360. (For all specific discussion of programming systems, refer to *IBM System/360 Programming Systems Summary*, Form C28-6510.)

Main Core Storage

Capacity of main core storage varies from 8,192 to 524,288 bytes, depending on the system model (Figure 2). A byte consists of eight bits plus a parity (check) bit, and is the smallest addressable unit in the IBM System/360. Storage capacities are always given in bytes.

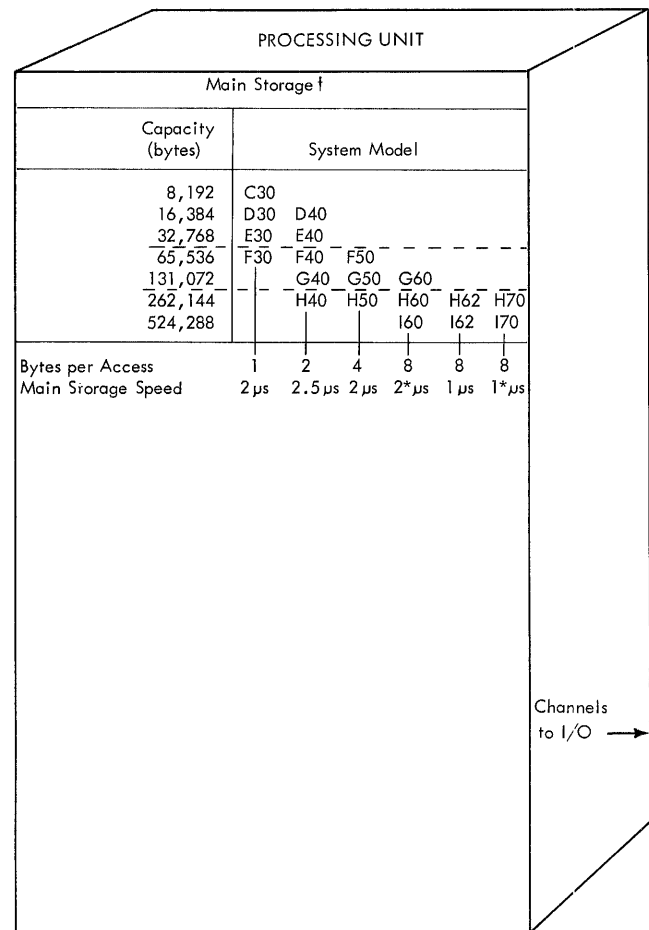

† Main Storage in Models 60-70 is housed externally to the processing unit.
 * Effective access time is less than the actual time specified, because of interleaving of storage.

Figure 2. Main Storage Capacity, Cycle Time, and Bytes Per Access

The history of data processing shows that the main barrier to expanding the work that can be done on a computer has been that the amount of core storage that can be addressed by a system rapidly becomes much too small as the jobs grow bigger. The System/360, however, has in its design the logical capability of addressing up to 16,777,216 bytes. (See "Large-Capacity Storage.") For greatest storage addressing efficiency, address arithmetic is done exclusively in binary. (See "Binary Arithmetic.")

Storage Protection

Storage protection prevents the contents of specified 2,048-byte blocks of storage from being altered by either errors in programs or input from I/O devices. As many as 15 different programs, each existing in any number of such storage blocks (which may be non-contiguous), can be protected at any one time. The number of programs and blocks depends on the capacity of main storage.

All input operations are monitored for violations of storage protection, and the control program is alerted and takes appropriate action when any such error occurs. This protection of storage, particularly vital for applications in communications, causes no loss of performance.

Shared Storage

Presently available for Model 50, the shared storage feature permits the main storage of two Model 50's to be shared and addressed by each as a single main storage. To share storage, the feature must be installed on both systems.

Large-Capacity Storage

The processing power of Models 50-70 can be expanded by adding large-capacity storage in blocks of either 1,048,576 or 2,097,152 bytes, to a maximum of 8,388,608 bytes. This storage is addressed contiguously with main storage. Speed of large-capacity storage is 8 microseconds. The number of bytes obtained per storage access, and all other features of large-capacity storage except cycle time, are the same as those of the main storage of the system.

Arithmetic

Decimal Arithmetic

The System/360 performs decimal arithmetic on signed decimal data packed two digits (or one digit and sign) per byte. Decimal operations are performed storage-to-storage, with the lengths of the variable fields being

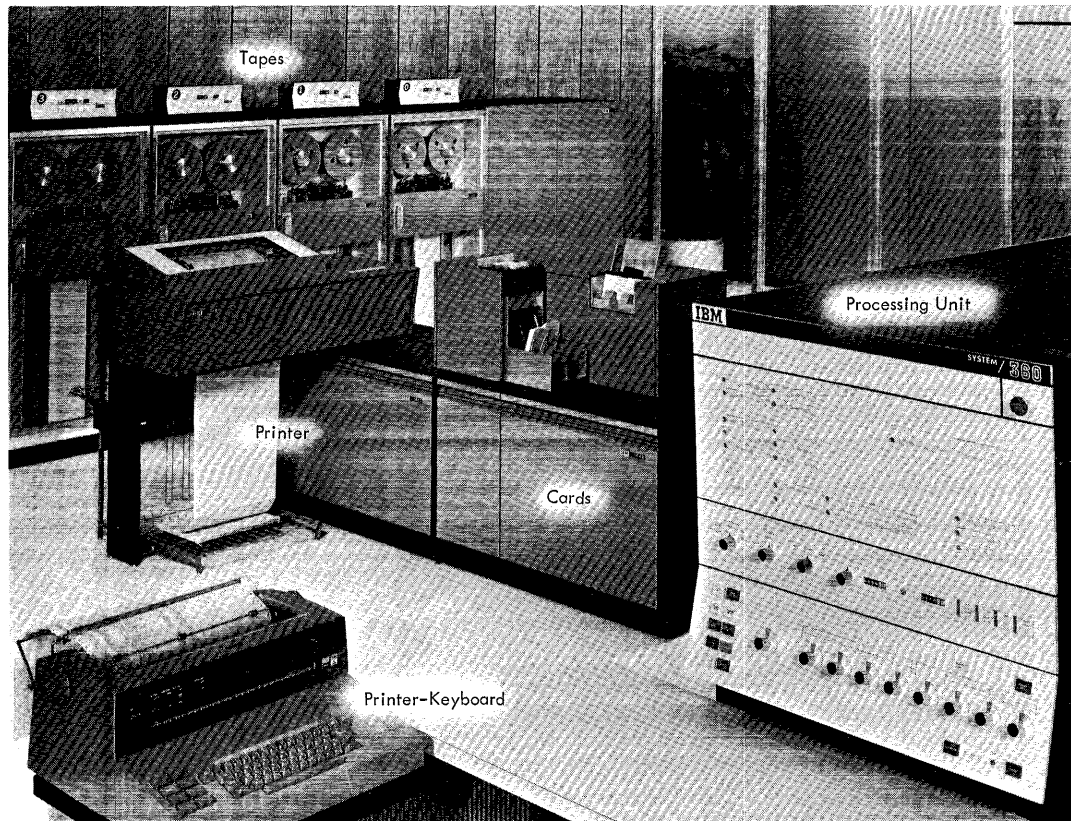

Figure 3. IBM System/360 Model 30

specified in the instruction. The maximum field size is 31 digits and sign.

Binary Arithmetic

The System/360 has 16 general registers that can be used for binary addition, subtraction, multiplication, and division; their primary use is in computing and modifying addresses within the program. The registers are all four bytes long, though two registers are sometimes coupled; for example, to preserve precision of the products and quotients in multiplication and division.

Floating-Point Arithmetic

When floating-point instructions are added to or included in the instruction set, four additional registers are provided with the system; all are eight bytes long; all floating-point arithmetic is done in them. The floating-point operations use the 16 general registers for indexing and address arithmetic.

The floating-point, which is basically a mathematical shorthand that reduces numbers to a fraction and a characteristic (exponent), can express decimal values ranging from about 2.4×10^{-78} to about 7.2×10^{75} . The use of floating-point greatly increases the speed and efficiency of computations.

The System/360 floating-point feature includes both short precision (four bytes) and long precision (eight bytes), for the use of either at the programmer's discretion. Short precision is used to minimize execution times and maximize the number of factors in storage. Long precision is used when maximum precision is desired; all models have both precisions and operate identically.

Instructions

Most instructions in the IBM System/360 have two data addresses; either address may be a register address or a storage address. Depending on the operation to be performed, instructions are two, four, or six bytes long.

The standard set of instructions provides the basic processing and logical instructions of the system. The addition of decimal arithmetic and editing facilities — important in commercial applications — forms the commercial set. The addition of floating-point instructions to the standard set forms the scientific set. Two instructions are provided to control storage protection. The universal instruction set, a standard facility on Models 50-70 and optional on Models 30 and 40, includes the standard set, the decimal, the floating-point, and the two instructions for storage protection.

Open-Ended Design

One of the chief lessons of the last decade of data processing is the desirability of open-ended design. The System/360 was designed in this way, and therefore lends itself to taking maximum advantage of new technology, new I/O devices, etc. A simple example of open-ended design is the capability of addressing more than 16,000,000 bytes of storage, thereby anticipating larger storage needs; another is judicious reservation for many new blocks of operation codes.

Interruption System

To make maximum use of a modern data processing system, some automatic procedure must be made available to alert the system to an exceptional condition, the end of an I/O operation, program errors, machine errors, etc., and send the system to the appropriate routine following the detection of such an event. The system must have, in effect, the ability to pause to answer the telephone and then to resume the interrupted work. This automatic procedure is called an interruption system.

Also, a main requirement for systems attempting to handle communications is the ability to be interrupted in any task in order to take on a task of higher priority.

The efficiency of any interruption system is based on the amount of time it takes to safekeep the reminders of where it was at the time of interruption, switch to the interruptive work, and then switch back to the interrupted work. This is done in the System/360 by one of the most advanced and efficient interruption systems ever conceived, suitable for the most rigorous demands of communication systems. (For further details, refer to "Interruption and Program Status Word.")

System Accuracy and Reliability

All data and instructions are monitored for invalid information by parity-checking throughout the system. Also, reliability is an inherent advantage of solid logic technology.

Programs are checked as they are executed. Because any interruptions caused by machine or program errors are at once classified by the interruption system and are treated differently, program errors cannot create machine errors; in this way, the causes of malfunctions can be and are clearly separated.

The compatible design of the System/360 makes it easy to couple together, either permanently or temporarily, a special system containing redundant I/O, storage, and processing units; thus, the expanded system can be made capable of operating even when components fail.

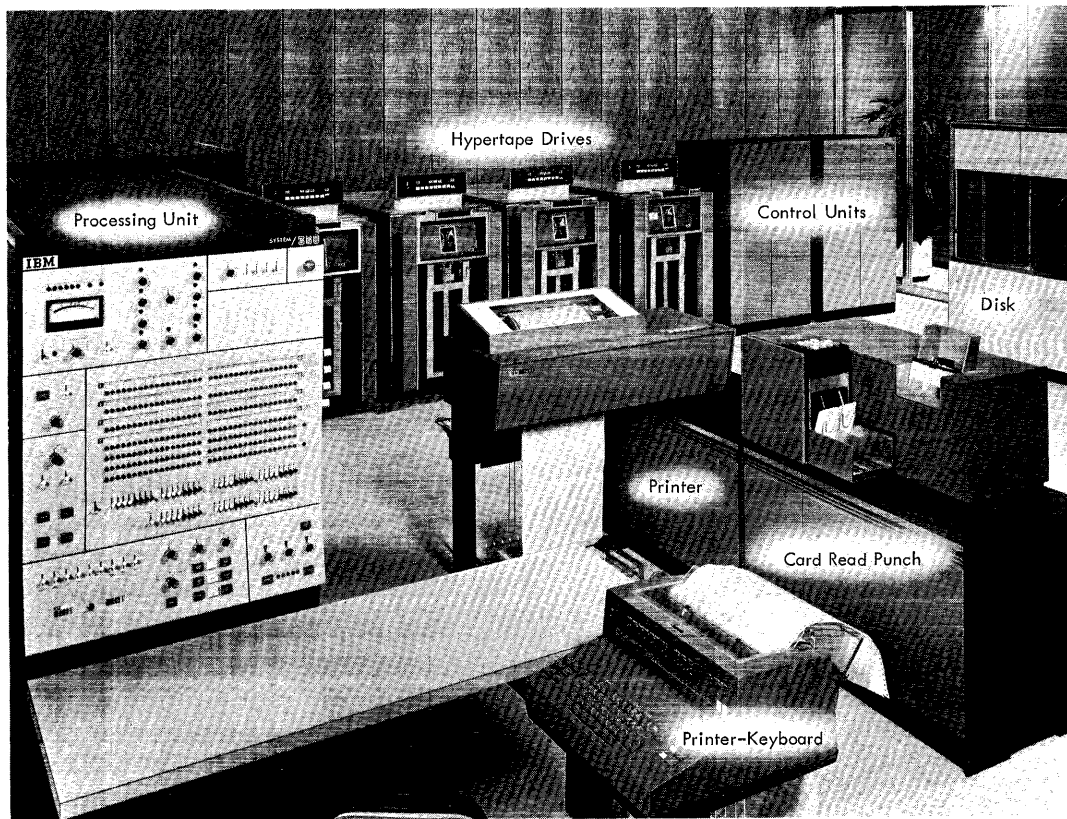

Figure 4. IBM System/360 Model 50

Universal Code Capability

The use of eight information bits for each character means that the System/360 can accept most character codes now in use or planned. The system provides defined operations for processing either the extension to the widely used BCD interchange code or the recently adopted American Standard Code for Information Interchange X3.4-1963 (ASCII).

An additional advantage of the eight bit character for alphameric data is the ability to pack two decimal digits in each byte, providing high data-packing efficiency in storage and on tapes and disks. Such packing is possible because decimal digits require only four information bits each, and is implemented because decimal data occur in business records more than twice as frequently as alphameric data.

Channels

Each System/360 channel directs the flow of information between main storage and those input-output devices the channel controls. The channel relieves the processing unit of the tasks of communicating directly with I/O and permits data processing to proceed concurrently with input-output operations. The channels are of two general types: multiplexor channel and selector channels.

Multiplexor Channel

The multiplexor channel, a completely new concept in data channels, separates the operations of high-speed devices from those of lower-speed devices. Operations on the channel are in two modes: a "multiplex" mode for lower data rates, and a "burst" mode for the higher.

In the multiplex mode, the single data path of the channel can be time-shared by a large number of low-speed I/O devices operating simultaneously; the channel receives and sends data to them on demand. When operating in the burst mode, however, a single I/O device captures the multiplexor channel and does not relinquish it from the time it is selected until the last byte is serviced.

Examples of low-speed devices that can operate simultaneously on the multiplexor channel are:

- Printers
- Card Punches
- Card Readers
- Terminals

The 2702 Transmission Control can transmit messages to the System/360 from many remote 1050 terminals, for instance, all of which may be operating intermittently or even simultaneously, but at relatively low data rates.

Examples of I/O devices that operate in the burst mode are tape units and disk, drum, or data cell storage.

The multiplexor channel has the effect of subdividing the data path into many subchannels (as many as 256). To the programmer, each such subchannel is a separate channel, and can be programmed as such. A different device may be started on each subchannel, and controlled by its own list of channel commands. (Refer to "Control of I/O.")

The multiplexor channel attaches up to eight I/O control units and addresses as many as 256 I/O devices, of which the number that can run simultaneously depends on the system model. Model 30 can operate 32 simultaneously, or, with an optional feature, 96. Model 40 can operate 128 devices simultaneously. Model 50 can operate 128 simultaneously, or optionally, all 256.

In the multiplex mode, data processing takes place while data are being transferred, thus increasing throughput by overlapping channel operations with processing. In the burst mode, processing is not overlapped in Models 30 and 40 but is overlapped in Model 50. (The multiplexor channel is available only for Models 30-50.)

Selector Channels

Selector channels transmit data to or from a single I/O device at a time and are capable of handling high-speed

I/O devices. Each selector channel attaches up to eight I/O control units and can address as many as 256 I/O devices. One I/O device per selector channel can be transmitting data at any given time; no other I/O device on the channel can transmit data until all data are handled for the selected device. With two or more channels, read/write/compute is possible. All selector channels might be reading or writing, or some reading and others writing, with or without simultaneous operation of the Models 30-50 multiplexor channel, while processing also takes place.

In general, I/O operations on a selector channel are overlapped with processing, and all channels can operate simultaneously, provided only that the processing unit's data rate capabilities are not exceeded. Nominal data rates for the selector channels range from 250 thousand bytes to 1.3 million bytes per second, depending on the system model and the channel options selected.

The only exception to the foregoing is a special high-speed selector channel available for Model 50, which operates in non-overlap mode.

One selector channel is required on Models 60-70; all others are optional. The number of selector channels on a given model thus ranges from none to two for the Models 30 and 40, none to four for the Model 50 (one of the four being the high-speed channel) and one to six for the Models 60-70.

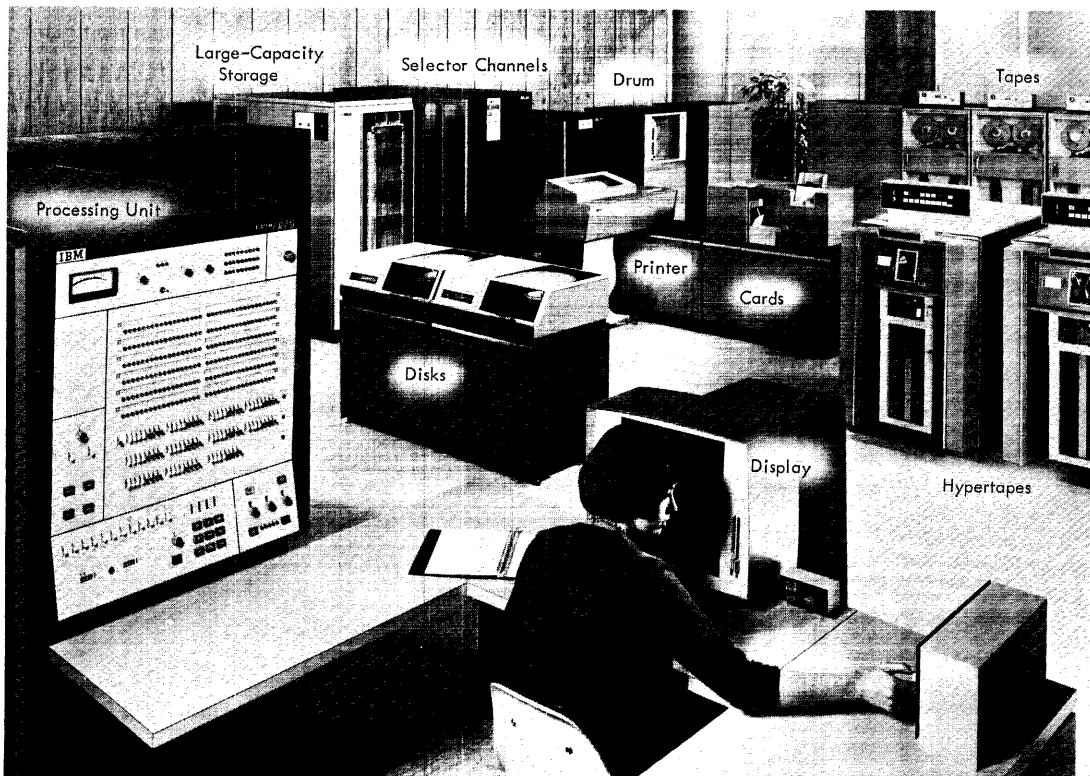

Figure 5. IBM System/360 Model 60

Channel Connector

Available for every channel (on Models 60-70) or just one of the channels (on Models 30-50) a channel connector provides a variety of uses that magnify the flexibility of the system. One use for the channel connector is to connect a selector channel on one system to a selector channel on another system, thereby providing intersystem communication. When this is done, each system appears like I/O equipment to the other.

NOTE: More than one channel connection may be made for a particular Model 30, 40, or 50, but the additional channel connector(s) must be physically installed on the other system(s); only one channel connector can be physically installed per Models 30-50.

Flexibility in Speed, Storage, Features, and I/O

The variations in system models, core storage capacity, optional features, and I/O configuration provide a flexibility that permits the system to be tailored to suit the individual user's exact requirements — with the added advantage of system growth without reprogramming.

The possible combinations of units and features, with distinctions between standard and optional features on different system models, are shown in the *IBM System/360 Configurator*:

Model 30: Form A24-3232
Model 40: Form A22-6813
Model 50: Form A22-6814
Model 60, 62: Form A22-6815
Model 70: Form A22-6816
Models 40-70 (Input/Output): Form A22-6823
Models 40-70 (Data Communications): Form A22-6824

Magnetic tape units and disk storage units can be employed in various combinations as high-speed I/O and for storing vast amounts of data in tape and/or disk libraries.

Input-output also includes data communications services, magnetic character readers, visual displays, many choices in rate and type of card input and card or printer output, voice output, and the numerous other I/O capabilities described under "Input/Output Devices" in this bulletin.

Standard Connections for I/O Devices

The physical connection between I/O devices and the channels is called the "I/O interface." All devices, regardless of their differences, can be connected to the system without adding new instructions to the processing unit or new channel commands. Basic control of devices of the future will be via the interface; consequently, I/O interface also represents an instance of open-ended design.

Multisystem

Several systems, of the same or different models, may be combined into a multisystem. See Figure 6. Three levels of communication among processing units are available. The largest in capacity and slowest in speed is communication via a shared I/O device; for example, a shared disk or drum storage. Faster transmissions are obtained by the direct connection between channels afforded by the channel connector previously discussed. Finally, storage may be shared between two Model 50 processing units.

Direct Control

Direct control provides a means of exchanging control signals between two System/360 processing units, or between a System/360 and some specialized I/O device such as an analog-digital converter. Direct control bypasses the channel.

System Panel

Operator errors are reduced by minimizing the active manual controls. The system panel containing the controls is attached to the processing unit and functionally divided into three sections: operator control, operator intervention, and Customer Engineering maintenance. The operator control section is physically and functionally identical for all models; the operator intervention

section is functionally similar for all models; the CE maintenance section for each model is unique.

Control over the system is concentrated at the system panel. The controls include stop, start, and selection of the unit for initial program loading. The operator control portion can be duplicated at a console elsewhere in the computer area.

1401 Compatibility

With the 1401 compatibility feature, the smallest models of the System/360 can execute 1401 instructions several times faster than the 1401 system. The complete 1401 instruction set is provided, with provisions also for the most generally useful 1401 features. This feature is used primarily as a conversion aid from 1401 systems to System/360. Only the following I/O devices available on the 1401 can be duplicated using I/O devices available on the System/360:

1. 729 and 7330 Magnetic Tape Units, using 2400 series tapes with the seven-track feature.
2. 1402 Card Read Punch, using the 1402 Card Read Punch Model N1.
3. 1403 Printers, using the 1403 or 2201 Printers.
4. 1311 Disk Storage Drive, using the 2311 Disk Storage Drive.
5. 1407 Console, using the System/360 system panel with the 1052 Printer-Keyboards.



Figure 6. Typical Multisystem Model 40 with Model 70

The Processing Unit houses the facilities for addressing storage, for arithmetic and logical processing of data, and for instructing channels to communicate with external devices.

Main Storage may be either physically integrated with the processing unit or separate from it, depending on the model. No logical differences are entailed.

Channels, likewise, may be either physically integrated with the processing unit or separate from it, depending on the model, as shown in the system configurators. When integrated with the processing unit, the channels share, to some extent, the processing unit circuits, resulting in cost and performance differences without differences in logical function.

The System Panel is attached to the processing unit (Figure 7).

Machine Addressing

Data in core storage are usually thought of as being physically stored in a table or block, with the positions of individual items being relative to the block origin. The System/360 makes use of this approach.

To this end, a two-part address format is used, with each address making reference to a base (the origin) and a displacement (the item location) related to that base. The base is given in the general register tagged by the instruction; the much shorter displacement is given in the instruction itself.

Using this approach, the System/360 can address more than 16,000,000 bytes, but without wasting storage by carrying a long data address in each instruction.

Furthermore, many instructions have a three-part address, in which two general registers are tagged — one for the base address and the other for an index — while the displacement is still used. Thus, the System/360 can index throughout a data area, using the displacement for local movement around a data point selected from the origin.

Formats

The System/360 has the capability of accepting inputs of many varying formats. Data field lengths may be fixed at one, two, four, or eight bytes, or variable from a minimum of one byte to a maximum of 256 bytes, in increments of one byte. The length of a variable field is specified within the instruction; the length of a fixed field is implicit in the instruction's operation code.

Editing, and arithmetic operations on decimal data, are performed using variable field lengths. Decimal numbers are also packed two per byte to conserve storage space (both main and file) and speed processing. This packing of decimal information also manifests itself in much higher I/O data rates.

Decimal numbers may also be changed to, or appear in, a "zoned" format, as required for I/O devices transferring alphameric characters at the time. In the zoned format, one byte contains one character (whether numeric, alphabetic, or special). Decimal numbers are easily changed by single instructions, from the zoned to the packed format and vice versa.

Interruption and Program Status Word

The interruption system, previously discussed under "System Concepts," makes possible the operation of a system in a non-stop environment and greatly aids the efficient use of I/O equipment. The desire to make the interruption procedure as short and simple as possible means that the method of switching between the interrupted program and the program that services the interruption must be quite efficient. It operates as follows:

The complete status of the System/360 is held in eight bytes of information. This status information, which consists of the instruction counter, condition code, storage protection key, etc., is saved when an interruption occurs, and is restored when the interruption has been serviced.

As soon as the interruption occurs, all the status information, together with an identification of the cause of the interruption, is combined into a double (eight-byte) "word" called the program status word (PSW). (In the System/360, a word is one of the units of information and consists of four consecutive bytes.)

The PSW is stored at a fixed location, the address of which depends on the type of interruption. The system then automatically fetches a new PSW from a different fixed location, the address of which is also dependent on the type of interruption. Each class of interruption has two fixed locations in main storage: one to receive the old PSW when the interruption occurs, and the other to supply the new PSW that governs the servicing of that class of interruption.

After the interruption has been serviced, a single instruction uses the stored PSW to reset the processing unit to the status it had before the interruption.

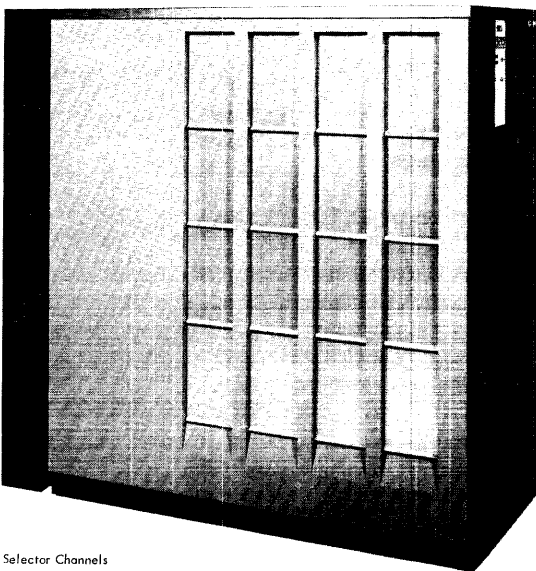
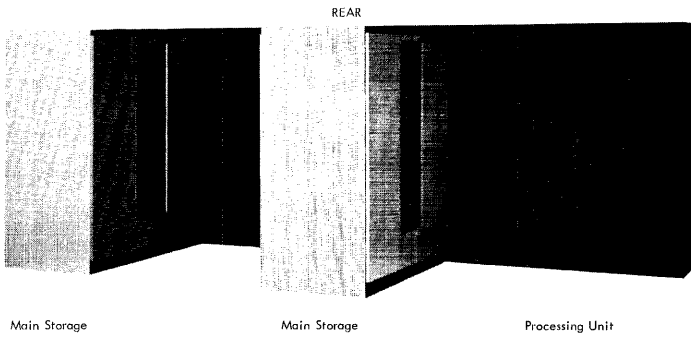
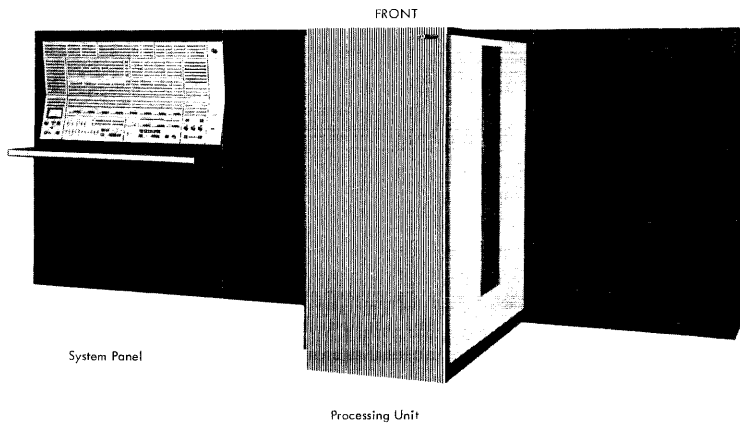

Figure 7. Essential Units in an IBM System/360 Model 70

The interruption system separates interruptions into five classes:

Program interruptions are caused by various kinds of programming errors; the exact type of error is displayed in the old rsw.

Supervisor Call interruptions are caused by the program issuing an instruction to turn over control to the supervisor (a type of master control program). The exact reason for the call is shown in the old rsw.

External interruptions are caused by either an external device requiring attention or by the timer going to zero. (The external device may be a signal from any device communicating via the direct control feature.)

Machine Check interruptions are caused by the machine-checking circuits detecting a machine error. The system is automatically switched to a diagnostic procedure.

I/O interruptions are caused by an I/O unit ending an operation or otherwise needing attention. Identifications of the device and channel causing the interruption are stored in the old rsw; in addition, the status of the device and channel is stored in a fixed location.

Some of the program interruptions, all external interruptions, and all I/O interruptions can be masked (ignored); when this is done, the external and I/O interruptions are held pending and taken at a later time (governed by the control program).

During the execution of an instruction, several interruptive events may occur simultaneously. When this occurs, the competing interruptions are serviced in a fixed order of priority.

Control of I/O

Each channel exerts direct control over all the I/O devices attached to it. However, I/O operations are initiated, halted, or tested (for masked I/O interruptions pending) by instructions from the control program. I/O operations are initiated by the start I/O instruction, which selects the unit and the channel that are to be used. If they are both available, the channel takes control. Using channel command words, the channel determines what operation is to be performed

(read, write, etc.) and where the data are stored.

The channel commands may be given in a list; this is called command chaining. The ability of successive channel instructions to give a sequence of different operations to the device — such as search, read, write, and check — permits the device to be reinstructed quickly, thereby increasing its effective data rate.

The channel contains the storage required for synchronization with the processing unit, and refers to main storage to either obtain or place information, a character or an entire message at a time. Instruction execution in the main program is not affected, except by the time delay introduced by the claiming by the channel of operating cycles between those used for the execution of program instructions.

The channel indicates the end of the I/O device operations by signaling an I/O interruption, storing the unit-and-channel address in the old rsw, and the channel status in a fixed eight-byte location. If the processing unit is not interruptible for I/O interruptions, that interruption is kept pending in the channel; any interruption queue in the several channels is serviced in a fixed order of priority.

I/O Equipment Pertaining to ASCII

The following input/output equipment will read and write the American Standard Code for Information Interchange (ASCII):

Magnetic Tape (2400 Series): The IBM 2400 magnetic tape units are code insensitive and hence can read and write ASCII at 800 bpi with an inter-record gap of 0.6 inch.

Auxiliary storage such as disk files are also code insensitive and hence can read or write ASCII.

Paper Tape: The IBM 2671 Paper Tape Reader and 2822 Paper Tape Control Unit will read the proposed American Standard perforated tape code for Information Interchange.

It is planned that other IBM input/output equipment will be made available to read or write the ASCII standard media when these are finalized.

Input/Output Devices

The following I/O devices, and/or the control units for them, can be attached to an IBM System/360. Nearly all can be attached to any model. (For the exceptions, see the system configurators.)

Visual

IBM 2250 Display Unit Model 1, 2
IBM 2840 Display Control
IBM 1015 Inquiry Display Terminal Model 1, 2
IBM 1016 Control Unit

Manual Controls

IBM 1052 Printer-Keyboard Model 1
IBM 1051 Control Unit Model 1, N1
IBM 2150 Console

Tape

IBM 2401 Magnetic Tape Unit Model 1, 2, 3
IBM 2402 Magnetic Tape Unit Model 1, 2, 3
IBM 2403 Magnetic Tape Unit and Control Model 1, 2, 3
IBM 2404 Magnetic Tape Unit and Control Model 1, 2, 3
IBM 2803 Tape Control
IBM 2804 Tape Control
IBM 7340 Hypertape Drive Model 3
IBM 2802 Hypertape Control
IBM 2816 Switching Unit Model 1, 2
IBM 2671 Paper Tape Reader
IBM 2822 Paper Tape Reader Control Unit

File

IBM 1302 Disk Storage Model N1, N2
IBM 2321 Data Cell Drive Model 1
IBM 7320 Drum Storage
IBM 2311 Disk Storage Drive
IBM 2841 Storage Control Unit
IBM 2301 Drum Storage
IBM 2820 Drum Storage Control

Card

IBM 1402 Card Read Punch Model N1
IBM 1442 Card Read Punch Model N1

Print

IBM 1403 Printer Model 2, 3
IBM 1404 Printer Model 2
IBM 2201 Printer Model 3
IBM 2821 Control Unit Model 1, 2, 3, 4
IBM 1443 Printer Model N1
IBM 1445 Printer Model N1

Magnetic Ink

IBM 1419 Magnetic Character Reader Model 1
IBM 1412 Magnetic Character Reader Model 1

Optical

IBM 1418 Optical Character Reader Model 1, 2, 3
IBM 1428 Alphameric Optical Reader Model 1, 2, 3
IBM 1231 Optical Mark Page Reader Model N1

Communications

IBM 2701 Data Adapter Unit
IBM 2702 Transmission Control

Communications Systems

IBM 1030 Data Collection System
IBM 1050 Data Communication System
IBM 1060 Data Communication System
IBM 1070 Process Communication System

Audio Communications

IBM 7770 Audio Response Unit Model 3
IBM 7772 Audio Response Unit Model 3

Visual Output

IBM 2250 Display Unit Model 1, 2

The IBM 2250 Display Unit (Figure 8) provides the System/360 with the capability of visually displaying tables, graphs, charts, and alphanumeric letters and figures. Data are presented within a 12-inch by 12-inch square area on the face of a 21-inch cathode ray tube.

A typical use of the 2250 is as a system operator console. Another application is the retrieval and presentation of a client's account record during a telephone inquiry. It is possible to update the record immediately and return the corrected data to storage.

The display area contains over 1,000,000 display points that can be addressed by X and Y coordinates. Fifty-two lines of 74 characters each can be displayed within the 12-inch square area.

A buffered system can accept data from the processing unit at up to 238 thousand bytes per second; characters can be displayed from the buffer at up to 60,000 per second. Lines may be displayed at any angle as a series of dots. Horizontal and vertical lines may be drawn by specifying only the end points of the lines; points may be displayed as fast as 16.8 microseconds per point.

The 2250 Model 1 has a self-contained control unit and is used in applications where a single console is required. The 2250 Model 2 is used for multiple displays.

Multiple Display

The IBM 2840 Display Control provides facilities for multiple display units. The standard 2840 control contains 8,192 bytes of core storage, a character generator, and controls for attaching two 2250 Model 2 Display Units. Features are available for expansion to as many as eight 2250 Model 2 Display Units on a single 2840 control. Core Storage and the character generator are time shared.

2250 Display Units may be located up to 2,000 feet away from the 2840 control unit. The 2250 Model 1 or the 2840 may be attached to either a multiplexor or selector channel.

All of the following optional features are available for the 2250 Display Unit Model 1. The two marked with an asterisk (*) are not available for the 2250 Model 2 because the control unit required for multiple displays already contains these items as standard equipment.

Light Pen: A hand-held, pen-like device used by the operator to identify to the program a particular point or character on the display screen. The light pen can be used alone or in conjunction with a keyboard to rearrange, delete, highlight or edit information.

Programmed Function Keyboard: A 32-key general-purpose keyboard, the keys of which are basically unidentified; with their functions defined by application-oriented interpretation programs. Illuminated and interchangeable overlays define the key functions to the operator.

Alphanumeric Keyboard is a typewriter keyboard that permits the entry of letters, numbers, and symbols into the display unit. This keyboard also controls the screen location of a movable electronic marker that can be used for data identification. Alphanumeric data are first displayed on the display screen and visually checked before transmission to the computer.

*Character Generator** translates a byte specifying an alphanumeric character into analog signals necessary to trace the character on the face of the tube; relieves the processing unit of the task of character generation. Two character sizes are program selectable.

*Buffer** provides the display unit with a choice of 4,096 or 8,192 bytes of internal storage. Buffer storage may be used to regenerate displays, thereby freeing main storage for other uses.

The following three features are available only for the 2840 control:

Additional Storage provides the 2840 control with an additional 8,192 bytes of core storage. This addition brings the storage capacity to its maximum of 16,384 bytes.

Display Multiplexor — 2 Additional — provides the 2840 with the ability to attach two additional 2250 Model 2 Display Units. A maximum of three such multiplexors can be added.

Display Multiplexor — 6 Additional — provides the 2840 with the ability to attach six additional 2250 Model 2 Display Units. Only one such multiplexor may be attached to a control unit.

IBM 1015 Inquiry Display Terminal Model 1, 2

This device and its IBM 1016 Control Unit make it possible for an operator to see records in main or auxiliary storage as needed, such as upon customer demand. The information is written at a rate of up to 650 characters per second, about 40 times faster than that produced for an operator by means of a typeout. Once written, the information is retained for as long as desired.

The viewing area has the capacity for 30 lines of 40 characters each, for a total of up to 1,200 characters at a time. Horizontal spacing is ten characters to the inch; vertical spacing, eight lines per inch. The characters standard for display are: all 36 alphanumeric characters plus 23 special characters. An additional four plotting characters are available as a special feature to provide a 60 by 80 matrix for plotting, such as bar graphs and trend curves.

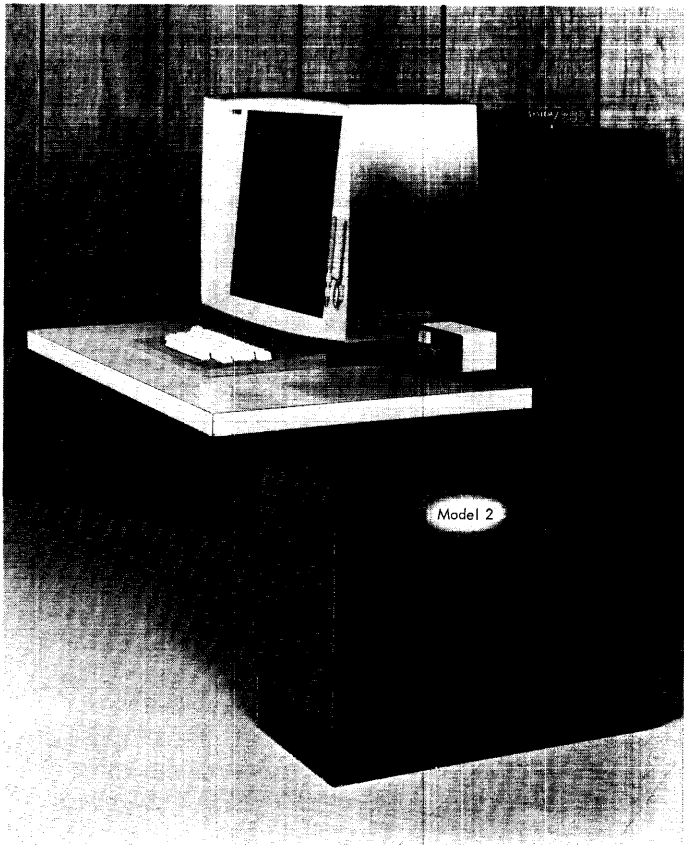
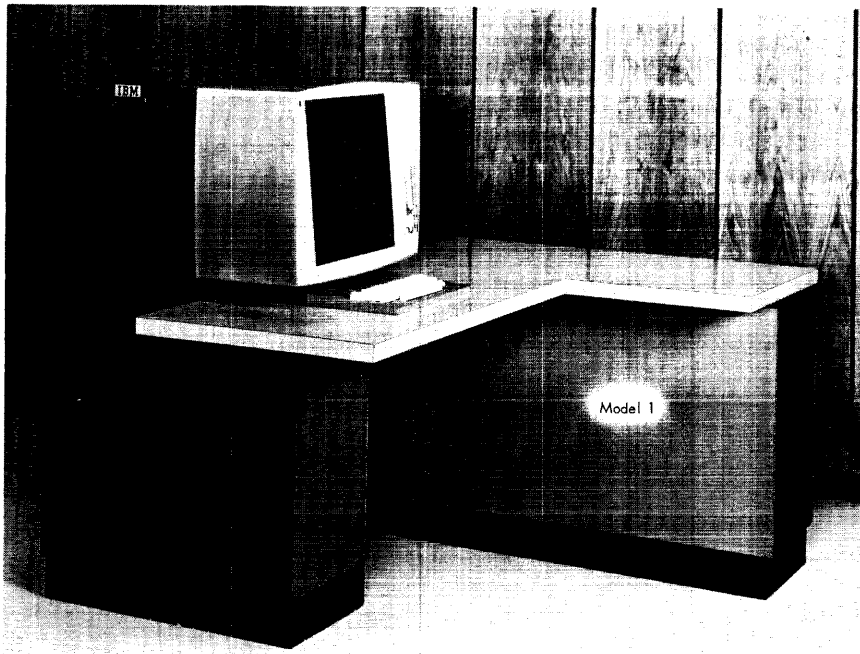

Figure 8. IBM 2250 Display Unit



Figure 9. IBM 1015 Inquiry Display Terminal

The 1015 consists of two functional units: the input keyboard used to signal for the records, and the output display. (See Figure 9.) Each 1016 can control up to ten Model 1 inquiry display terminals. To each Model 1 can be attached as many as five Model 2's, which differ only in that Model 1 supplies the common power and must be turned on for attached Model 2's to operate. The five Model 2's can be attached by three separate cables, in any combination of terminals per cable.

The IBM 1016 Control Units are connected to the multiplexor or selector channels. Each inquiry display terminal can be located up to 2,500 cable-feet distant from its control unit.

Manual Controls

IBM 1052 Printer-Keyboard Model 1

The IBM 1052 Printer-Keyboard Model 1 (Figure 10) can be attached to the system for communication between the operator and the system; e.g., such operator-to-program or program-to-operator communication as program checking, program correction, and job logging.

The keyboard and the printing are electrically and mechanically independent of each other. The keyboard can be used for system input, and the printer accepts computer output. A single keyboard depression causes an I/O interruption, and a double keyboard depression signals the end of data entry.

The 1052 prints at 14.8 characters per second. It has a replaceable printing head and a typewriter style keyboard.

The 1052 may be attached to Models 40-60 via the 1052 adapter in the processing unit, which adapter provides all the necessary control signals. In Model 30, the 1052 is attached via a 1051 Control Unit (Figure 10). In Models 60-70, the 1052 may be attached via the 2150 Console (Figure 11). In Models 30-50, the device operates on the multiplexor channel in the multiplex mode.



Figure 10. IBM 1052 Printer-Keyboard, 1051 Control Unit, 1443 Printer, and 1442 Card Read Punch

IBM 1051 Control Unit Model 1, N1

The IBM 1051 Control Unit Model 1, N1 (Figure 10) provides the control circuitry necessary when either the 1052 Printer Keyboard or the additional units of a 1050 system are attached to a System/360 (Model 30 only).

The maximum configuration of a 1050 system attached via the 1051 is one 1052, one 1053 printer, one 1054 or 1056 reader, and one 1055, 1057, or 1058 punch.

(The 1050 system may also be connected to the System/360 via communication devices. See "IBM 1050 Data Communication System," "IBM 2701 Data Adapter Unit," and "IBM 2702 Transmission Control.")

The optional home component recognition feature permits any component in an attached 1050 system to be turned on and off under channel control rather than by keys at the 1052 keyboard.

IBM 2150 Console

The IBM 2150 Console provides the IBM System/360 Models 60-70 with operators' controls duplicated at a station removed from the processing unit (Figure 11). Facilities may be provided on the console for up to three operator control panels, to control any of three systems in a multisystem, which, in this case, may



Figure 11. IBM 2150 Console, 1402 Card Read Punch, and 1403 Printer

include a Model 50. The console includes an adapter for the IBM 1052 Printer-Keyboard.

The need for operator manipulation of manual con-

trols is held to a minimum by the system design and the supervisor program. The results are fewer and less serious operator errors.

Tapes

IBM 2400 Series Magnetic Tape Units

The new IBM 2400 series magnetic tape units (Figure 12) provided for the System/360 read or write nine tracks on half-inch MYLAR* standard or heavy-duty magnetic tape at a density of 800 bytes per inch. A byte contains an alphameric character or two decimal digits as packed by the computer.

The following tape units and controls are available:

- IBM 2401 Magnetic Tape Unit (Single drive)
- IBM 2402 Magnetic Tape Unit (Two drives)
- IBM 2403 Magnetic Tape Unit and Control (Single drive and a control)
- IBM 2404 Magnetic Tape Unit and Control (Single drive and a simultaneous read-write control)

Each drive is available in three models:

- Model 1 (22,500 bytes per second)
- Model 2 (45,000 bytes per second)
- Model 3 (90,000 bytes per second)

Each tape control can control as many as eight tape drives. The simultaneous control attaches to two channels in a manner that permits a read-type operation on one tape drive to be overlapped with a simultaneous write, write tape mark, or erase tape operation on another drive. Controls attach to a selector or multiplexor channel and operate in the burst mode.

*Trademark of E. I. duPont de Nemours & Co. (Inc.)

Tape controls are also available in two stand-alone versions:

- IBM 2803 Tape Control
- IBM 2804 Tape Control (Simultaneous)

Any model of tape drive can be controlled by any tape control. Characteristics of the three tape drive models are shown in Figure 13.

Characteristic	Model 1	Model 2	Model 3
Data Rate (kb/kd)*	22.5/45	45/90	90/180
Tape Speed (ips)	28.125	56.25	112.5
Density (bpi)	800	800	800
Nominal Inter-record Gap (inches)	.6	.6	.6
Nominal Inter-record Gap Time (millisec)	21.2	10.6	5.3
Rewind Time (minutes)	3.2	2.6	1
Rewind Unload Time (minutes)	2.2	2.2	1
Tape Width (inches)	.5	.5	.5
Number of Tracks	9	9	9

*kb = thousands of bytes per second.
kd = thousands of decimal digits per second.
ips = inches per second.
bpi = bytes per inch.

Figure 13. Characteristics of IBM 2400 Series Magnetic Tape Drives

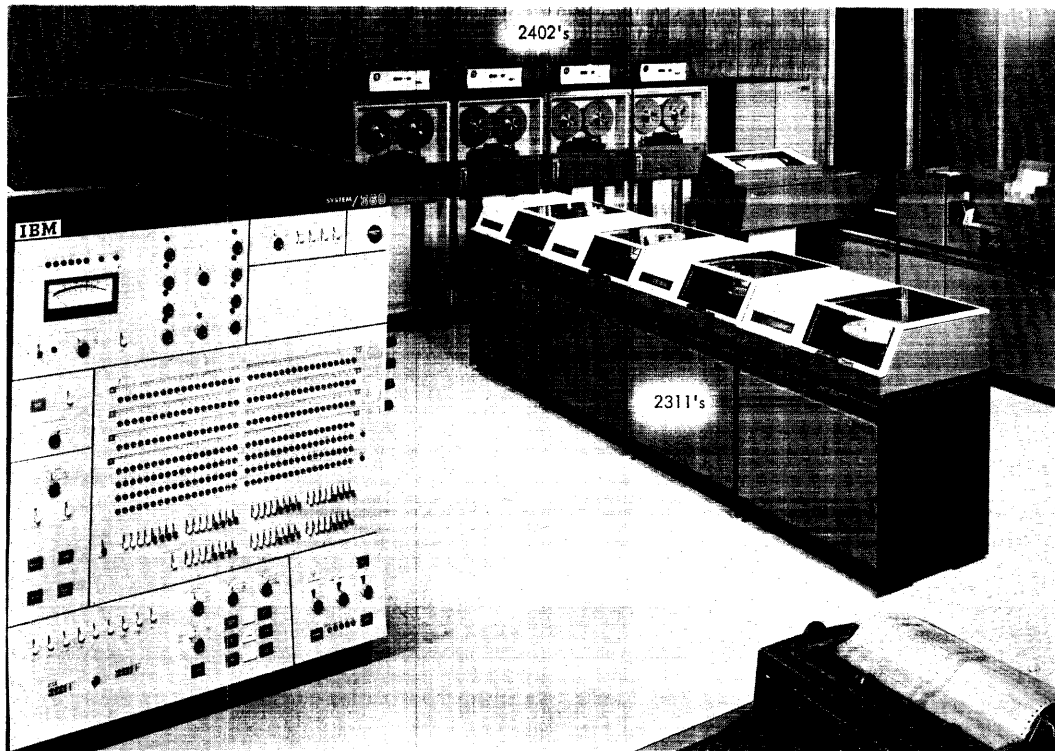

Figure 12. IBM 2402 Magnetic Tape Unit and 2311 Disk Storage Drive

An optional sixteen-address feature enables a tape control to address as many as sixteen tape drives when used with the IBM 2816 Switching Unit(s) Model 1, available for switching 4, 8, 12, or 16 tape drives to any one of from two to four control units under program control. This feature can be used with the 2401, 2402, 2403, or 2803.

An optional seven track compatible feature enables a 2400 series tape drive and control to write or read seven-track tape, which is compatible with IBM 729 and IBM 7330 Magnetic Tape Units at 200, 556, or 800 characters per inch. As part of the seven track compatible feature, a code translator feature is included to translate the BCD interchange code to the universal System/360 code.

Seven track compatible feature installations may have an optional data conversion feature that converts three 8-bit bytes to four 6-bit characters or vice versa; for example, for handling binary data on seven-track tape.

Error correction is a standard feature of IBM 2400 series magnetic tape units; it provides error correction on a reread of a record containing one or more errors in a single track. The reread automatically corrects almost every single track error on the nine-track tape.

Other standard features are tape in column load, whereby tape automatically enters the tape columns after a reel is mounted and threaded and the load key is pressed, and read backward, which speeds tape sorting by eliminating certain rewind operations.

IBM 7340 Hypertape Drive Model 3

The IBM 7340 Hypertape Drive Model 3 and its IBM 2802 Hypertape Control (Figure 4) provide the IBM System/360 with the newest high performance magnetic tape input and output.

In the low-density mode (Figure 14), the Model 3 Hypertape drive can read tape written by Model 1 or 2 Hypertape, with character translation performed by the System/360 program.

High reliability is provided by Hypertape's 10-track recording; all read and write errors are detected, and, when reading, all single-bit errors and 33 of the possible 45 double-bit errors are corrected automatically.

Read backward (which speeds tape sorting by eliminating certain rewinds) and automatic threading and unthreading of tape are standard features. Tape for Hypertape drives is provided inside a cartridge that eliminates all tape contamination or damage owing to manual handling.

The IBM 2802 Hypertape Control can control up to eight 7340-3 drives. It attaches to the selector or multiplexor channel if Hypertape operation is at the

Tape Speed	
Read, Write, Read Backward	112.5 inches per second
Rewind	225 inches per second (after 10 sec) 112.5 inches per sec (first 10 sec)
Rewind Time (approximate)	90 seconds
Recording Density (Program-controlled)	
Low	1511 bytes per inch
High	3022 bytes per inch
Data Packing	Computer can pack two decimal digits in each byte
Data Rate	
Low	170,000 bytes per second
High	340,000 bytes per second
Nominal Inter-record Gap	0.38 inches
Nominal Read/Write Access Time	3.5 milliseconds
Tape Cartridge	
Tape Width	1 inch
Tape Length	1,800 feet
Data Capacity	As many as 128,374,560 packed decimal digits and signs
Automatic Cartridge Loader Optional Feature	
Change Cartridge Cycle	30 seconds

Figure 14. Highlights of IBM 7340 Hypertape Drive Model 3

“low” data rate of 170,000 bps, or to a selector channel of appropriate data handling capacity if Hypertape operation is at the “high” data rate of 340,000 bps. Hypertape operation at the low or high data rate is specified by the program. An optional sixteen-address feature enables the 2802 to address as many as sixteen 7340-3 drives when used with the IBM 2816 Switching Unit(s) Model 2, which is available for switching 4, 8, 12, or 16 7340-3 drives to any one of up to four 2802 units under program control.

IBM 2816 Switching Unit Model 1, 2

With the 16-drive control feature installed on the appropriate tape controls and the addition of two IBM 2816 Switching Units, a maximum of 16 tape drives may be controlled in common by a maximum of four tape controls. The minimum is control of four tape drives by two tape controls; any combination between the minimum and maximum is available. For more than eight drives, the second switching unit is required.

Model 1 of the switching unit is used for switching tape drives in the 2400 series. The drives in the tape-switching pool may be located in any model of 2401, 2402, or 2403. The tape controls involved may be in the IBM 2403 Magnetic Tape Unit and Control or the 2803 Tape Control.

Model 2 of the switching unit is used for switching Hypertape.

If the 16-drive control feature is not installed on a tape or Hypertape control, it can control only the first eight drives in the tape or Hypertape pool.

IBM 2671 Paper Tape Reader

The IBM 2671 Paper Tape Reader (Figure 15) photo-electrically reads strips of 5-, 6-, 7-, or 8-channel paper tape at a rate of up to 1,000 characters per second. Internal parity error detection is provided. Tape code translation is under program control, facilitated by various switches on the 2671. This device is especially designed for data communications, source recording, for use in scientific data processing, and for data acquisition.

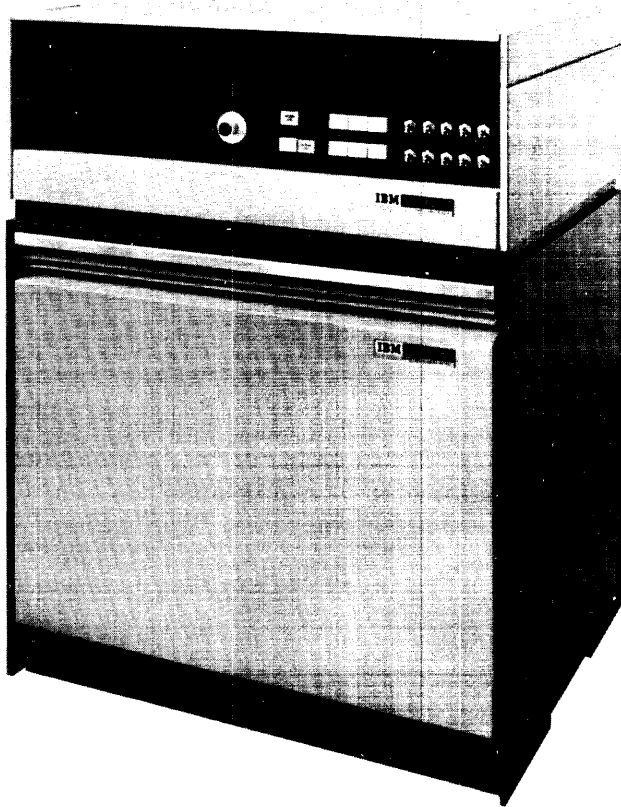

Figure 15. IBM 2671 Paper Tape Reader and 2822 Paper Tape Reader Control Unit

The paper tape reader and its IBM 2822 Paper Tape Reader Control Unit are normally attached to the System/360 through the multiplexor channel but may be attached to a selector channel.

The basic 2671 reads strips of paper tape, of any lengths that are practical for operator handling. With the optional supply feature, 10½ inch rolls of paper tape can be fed, from either the center of the roll

or from the outside of the reel. With the optional take-up feature, the tape can be rewound on a 10½ inch reel.

After acceleration time (about 18 milliseconds), the data rate reaches 1,000 characters per second for strips. With the optional "spooling" facilities, the data rate varies between 500 and 1,000 cycles per second, depending on the length of a record.

Files

IBM 1302 Disk Storage Model N1, N2

The IBM 1302 Disk Storage (Figure 16) can record and retrieve data either at random or sequentially; the random capability permits immediate access to specific areas of information without the need to sequentially examine all the data in the file. The speed of the access enables the user to maintain up-to-the-second data files and make frequent retrievals of the data stored.

The 1302 Model N1 contains one disk storage module; the Model N2 contains two disk storage modules. Capacity per module is 112.14 million bytes (or 224.28 million packed decimal digits and signs). Eight accesses (four modules) may be connected to the System/360 through an IBM 2841 Storage Control Unit, for on-line random access to 448.56 million bytes (or 897.12 million packed decimal digits and signs) per 2841 attached. Each module has two access mechanisms. A special feature on the control unit permits eight more access mechanisms, with four additional modules of disk storage, to be addressed by that control unit.

The recording medium consists of thin, magnetically-coated metal disks that spin at about 1,800 revolutions per minute. Each disk surface is divided into 500 tracks; data and control information are recorded as magnetized spots on a track. Access times are 50 milliseconds minimum, 180 milliseconds maximum, and 165 milliseconds average. The transfer rate between the 1302 and the processing unit is 156 thousand bytes per second.

IBM 2321 Data Cell Drive Model 1

The IBM 2321 Data Cell Drive (Figure 17) economically extends on-line random access storage capabilities to a volume of data beyond that of other storage devices. Each 2321 offers 400 million bytes (or 800 million packed decimal digits and signs) of on-line data. Eight 2321's may be attached to a 2841 Storage Control Unit, for a total on-line capacity of 3.2 billion bytes or 6.4 billion packed decimal digits and signs per 2841 control unit. The data rate is 55 thousand bytes per second.



Figure 16. IBM 1302 Disk Storage and 2201 Printer

Each data cell drive contains from one to ten data cells, each having a capacity of 40 million bytes. The data cells are all removable and interchangeable, permitting an open ended capacity for libraries of data cells.

The storage medium is a strip of magnetic tape $2\frac{1}{4}$ inches wide by 13 inches long. Each data cell contains 200 of these strips, divided into 20 subcells of 10 strips each. A rotary positioning system aligns the selected subcell beneath the access station. Access time to a strip varies from 175 milliseconds to 600 milliseconds, depending on the addressed strip position and data arrangement in the 2321. Each data cell is interchangeable with any data cell in any IBM 2321 Data Cell Drive.

IBM 7320 Drum Storage

The IBM 7320 Drum Storage (Figure 18) provides on-line random access storage of 830,000 bytes (or 1.66 million packed decimal digits and signs) on a magnetic drum. Eight 7320's may be attached to each

2841 Storage Control Unit, for total on-line random access storage of 6.64 million bytes per 2841.

The drum rotates at about 3,500 revolutions per minute and is divided into 400 tracks; each track may contain as many as 2,075 bytes of information. The maximum data rate is 135 thousand bytes per second.

Because of the assignment of a read-write head to each track, no access delay is encountered in seeking an addressed track. The rotational delay to the specific record on the track ranges from zero to about 17 milliseconds and averages 8.6 milliseconds.

IBM 2311 Disk Storage Drive

The IBM 2311 Disk Storage Drive (Figures 12 and 19) provides random access storage for 7.25 million bytes (or 14.5 million packed decimal digits and signs) on a single disk pack. Eight disk storage drives can be attached to each IBM 2841 Storage Control Unit, for a total on-line capacity of 58 million bytes per 2841. In addition, unlimited storage capacity is possible because

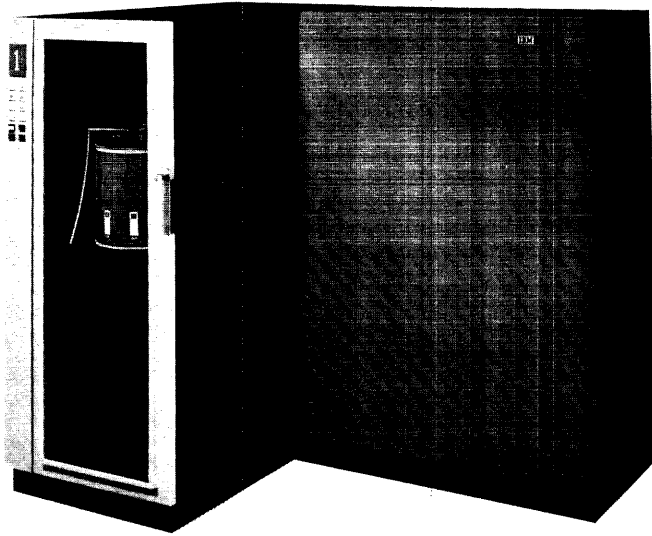

Figure 17. IBM 2321 Data Cell Drive Model 1

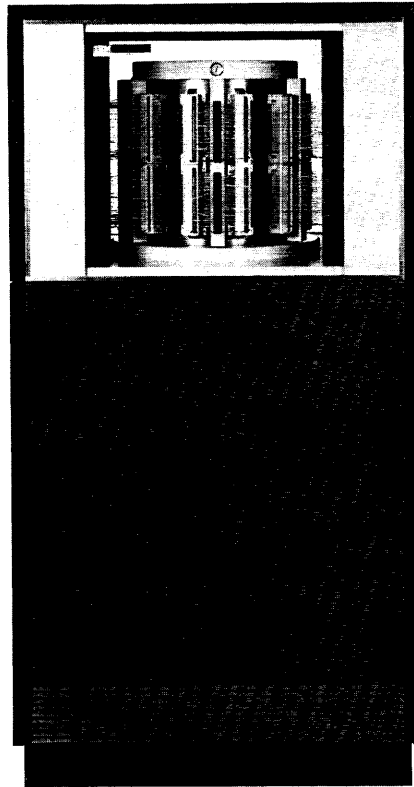

Figure 18. IBM 7320 Drum Storage

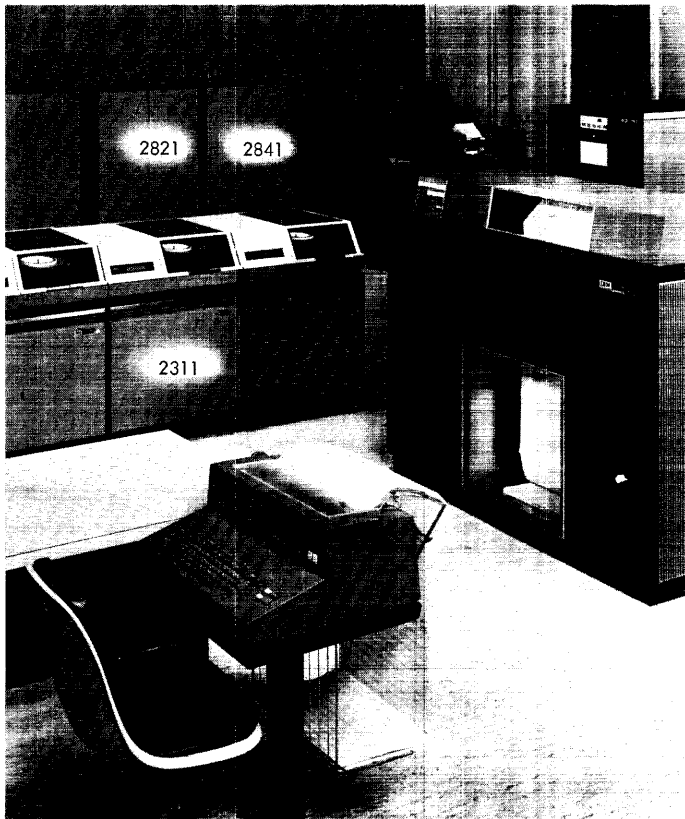

Figure 19. IBM 2311 Disk Storage Drive, 2841 Storage Control Unit, and 2821 Control Unit

the disk pack in each drive can be easily removed and replaced with another in less than 1 minute.

The disk pack weighs only 10 pounds; each has six 14-inch disks, mounted ½ inch apart on a vertical shaft. The inside ten disk surfaces are used for recording data and the outermost two surfaces are protective plates. When the disk pack is installed in the disk storage, information is written on or read from the disk surfaces by magnetic read/write heads, mounted in pairs between each two disks on a movable comb-like access mechanism.

The data rate of the IBM 2311 is 156 thousand bytes per second. Sequential track-to-track access time is 30 milliseconds. The maximum seek time is 145 milliseconds, and the average seek time is 85 milliseconds. The average rotational delay is 12.5 milliseconds.

IBM 2841 Storage Control Unit

The IBM 2841 Storage Control Unit (Figure 19) provides the capability of attaching serial-by-bit types of random access storage devices to the IBM System/360. Adapters are available for the 2841 to control these storage units:

- IBM 1302 Disk Storage Models N1, N2
- IBM 2311 Disk Storage Drive
- IBM 2321 Data Cell Drive
- IBM 7320 Drum Storage

Adapters can be mixed to provide 2841 control of up to eight *access mechanisms*, in any combination, on the above units.

ACCESS MECHANISMS PER FILE

- 1302 N1 Two Access Mechanisms (one module)
- 1302 N2 Four Access Mechanisms (two modules)
- 2311 One Access Mechanism
- 2321 One Access Mechanism
- 7320 Rated Equivalent of One Access Mechanism

FILES PER 2841

(One of the following, when adapters are not intermixed)

- 1302 N1 4
- 1302 N2 2
- 2311 8
- 2321 8
- 7320 8

The 2841 interprets and executes all orders from the system, and checks the validity of the data transferred to and from the storage devices.

Optional Features

The two-channel switch permits switching a 2841 between two channels.

Scan permits searching through random access stor-

age for a specific record or condition.

The additional storage feature enables a 2841 to control and address eight additional 1302 access mechanisms (four more modules), thus doubling the total on-line capacity in 1302's.

The record overflow feature provides greater utilization of the available storage capacity by allowing a record to "overflow" from one track to another. The maximum capacity of an overflow record is two tracks.

IBM 2301 Drum Storage

The IBM 2301 Drum Storage (Figure 20) provides random access storage of approximately 4 million bytes at a data rate of 1.2 megabytes per second. The high data rate is partially achieved by accessing four bits of information in parallel rather than in series; thus the com-

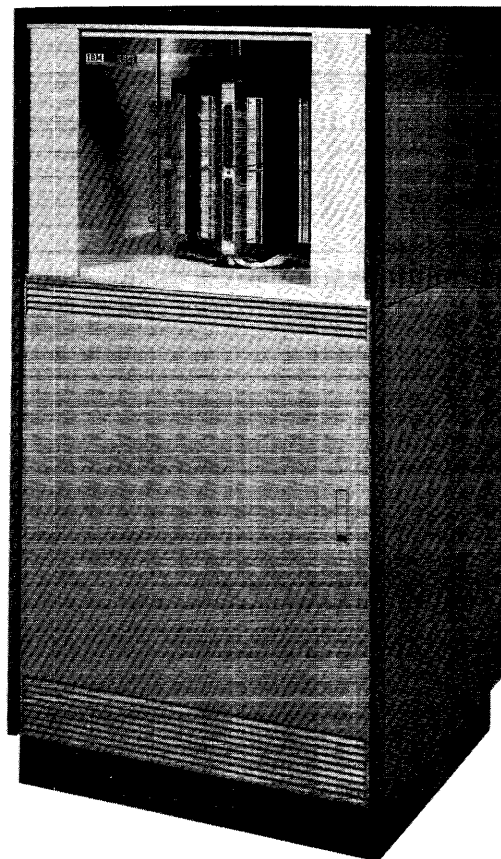

Figure 20. IBM 2301 Drum Storage

mon reference to this as a "parallel" file. Data are recorded on 800 tracks, divided into 200 addressable groups of four tracks read in parallel. Access time averages 8.6 milliseconds.

Data records can be of variable length.

The IBM 2820 Drum Storage Control provides the capability of attaching up to four IBM 2301 Drum Storage units to a System/360 channel, for a total on-line

random access capacity of 16 million bytes or 32 million packed decimal digits and signs per 2820 attached.

The 2820 interprets and executes all control orders received from the channel, and checks the validity of the data transferred to or from the storage devices.

The optional two-channel switch permits switching a 2820 Drum Storage Control between two channels.

Card Input/Output

IBM 1402 Card Read Punch Model N1

The IBM 1402 Card Read Punch Model N1 (Figure 11) reads cards at a rate of 800 per minute, and punches cards at a rate of 250 per minute. The card read and punch sections are separate entities, except for one common pocket out of the five, and reading and punching can take place simultaneously.

The 1402 is controlled, buffered, and attached to the System/360 channel by an IBM 2821 Control Unit Model 1 or 4.

An optional 51-column interchangeable read feed feature permits the feeding of either 51-column cards or standard 80-column cards in the read feed of the machine. The 51-column cards may be postal money-order forms, installment payments, inventory cards; for example, a detached 51-column stub from an 80-column card.

An optional punch read feed feature enables the 1402 to read back into the system data from a card, between the time that card is punched and the time it is stacked.

IBM 1442 Card Read Punch Model N1

The IBM 1442 Card Read Punch Model N1 (Figure 10) uses a single common card path for reading and punching, and reads and punches cards serially by card column. Serial card feeding, past a read and then a punch station, makes it possible for the program to

read data from a card, then hold the card at the next consecutive card column, and then punch data (such as the results of a calculation) into the same card, all during a single card pass.

The IBM 1442 Model N1 reads or punches cards at the following maximum rates:

Reading – 400 cards per minute
Punching – 160 card columns per second

The 1442 is an I/O device typically operated on the multiplexor channel, but it may be attached to a selector channel. The control circuits are within the 1442.

The 1442 Model N1 reads and punches an extended card code that permits punching any of 256 different combinations of holes in each card column. The optional card image feature permits the low-order six bits of bytes read from the processing unit to be punched into the upper six or lower six rows of a card, enabling 160 bytes to be placed in the card. On reading, the information is read column by column and transmitted to the processing unit byte by byte, with two high-order bits (6 and 7) being set to zero. Interspersed cards punched in either the normal or the card image mode may be read.

The read hopper holds 1,200 cards. Card movement is from the hopper to the read station, to the punch station, then to one of the two stackers (pockets). The stackers hold 1,200 cards each, and cards can be removed from either stacker without stopping the machine.

Printers

IBM 1403 Printer Model 2, 3

Two different models of the IBM 1403 Printer (Figure 11) can be attached to the System/360. Model 2 prints at a rate of 600 lines per minute; Model 3 prints at a rate of 1,100 lines per minute.

The 1403 (either model) is controlled, buffered, and attached to the System/360 channel by an IBM 2821 Control Unit Model 1 or 2. One or two additional 1403 printers (either model) can be serviced by a 2821 Model 3, with a 2821 Model 1 or 2 as a prerequisite.

An auxiliary ribbon feeding feature adapts the printer (Model 2) to use polyester ribbons for sharper impressions.

The 1403 Model 2 uses a chain of linked characters for printing, and the Model 3 uses a train of characters that are not linked together. As an optional feature, an interchangeable chain cartridge adapter is available for the Model 2, or an interchangeable train cartridge adapter is available for the Model 3; either cartridge adapts the 1403 for quick and convenient changing of type fonts for special printing jobs.

The numeric print feature, available for Model 2, permits a step-up in line speed for jobs involving numeric-only printing. When the feature is installed, the speed-up is accomplished by merely changing the

chain cartridge in the 1403. The numeric chain is made up of 15 character sets, with 16 characters in each set (digits 0 through 9 and \$. , * - □). In the numeric mode, the 1403 can print 1,285 lines per minute – more than twice as fast as in the alphameric mode.

The optional selective tape listing feature provides the capability of substituting longitudinal strips for the normal paper sheet forms; this feature is available for the 1403 Models 2 and 3. A preferred character set feature is available for Model 3 only. For details on these features, both of which are available for the 2201 Printer and operate the same way, refer to the section entitled “IBM 2201 Printer Model 3.”

IBM 1404 Printer Model 2

The IBM 1404 Printer Model 2 (Figure 21) can print on continuous paper forms at a speed of 600 lines per minute, or it can print on cards at a maximum rate of 800 cards per minute.

When the bill feed is engaged, the 1404 accepts cards, of a variety of lengths and one or two at a time, for printing. Lengths can range from 51 columns to 160 columns (80-column card with 80-column stub). Cards from 51 to 80 columns long can also be fed side by side (“two up”); when this is done, the cards may be intermixed in any combination within the 51-80 column-length range; the 800-card per minute rate is reached by this doubled throughput.

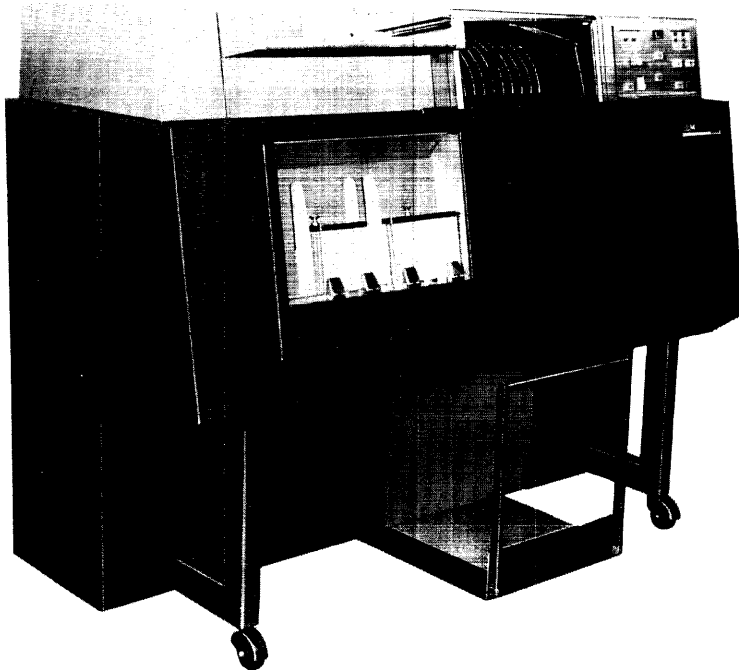

Figure 21. IBM 1404 Printer

As many as 25 lines of data can be printed on each card fed. With the optional read-compare feature, punched information (up to 30 columns) from the card itself may be printed on the card during the same pass — or used as a base for computations by the system, with the results printed on the same card during the pass.

The 1404 is controlled, buffered, and attached to the System/360 by an IBM 2821 Control Unit Model 4.

The 1404 uses a chain of linked characters for printing. As an optional feature, an interchangeable chain cartridge adapter is available to adapt the printer for quick and convenient changing of type fonts for special printing jobs.

IBM 2201 Printer Model 3

The IBM 2201 Printer Model 3 (Figure 16) represents a new line of printers that combine the proved performance of the 1403-type printing with the latest circuitry and packaging techniques. The 2201 has 132 print positions and a speed of 1,100 lines per minute.

The optional selective tape listing feature provides the capability of substituting longitudinal strips for the normal paper sheet forms. Four 3-inch wide tapes or eight 1½-inch wide tapes, or any combination of these up to 12 inches wide, may be printed.

In the standard character set, there is a regular distribution of the 48 characters in five identical groups. In the optional preferred character set, the 48 characters are distributed irregularly, with more of some and fewer of others than in the standard character set. This produces print rates of three levels, depending on the characters printed:

1400 lines per minute for the 10 numeric digits and . , * -
950 lines per minute for the 26 letters and % \$ / &
500 lines per minute for the characters ← @ # +

When characters from different levels are intermixed, the speed becomes variable at rates between the levels.

The 2201 is controlled, buffered, and attached to the System/360 by an IBM 2821 Control Unit Model 1 or 2. One or two additional 2201 printers can be serviced by a 2821 Model 3, with a 2821 Model 1 or 2 as a prerequisite.

IBM 2821 Control Unit Model 1, 2, 3, 4

The IBM 2821 (Figure 19) contains the control and buffer circuitry to transmit information between the associated System/360 channel and the IBM 1402 Card Read Punch Model N1, and/or one of the following printers: IBM 1403 Printer Model 2 or 3, IBM 2201 Printer Model 3, or IBM 1404 Printer Model 2. The 2821 is in four models:

Model 1 controls and buffers one 1402-N1 card read punch plus one 1403-2, 1403-3, or 2201-3 printer.

Model 2 controls and buffers one 1403-2, 1403-3, or 2201-3 printer.

Model 3, with a Model 1 or 2 as a prerequisite, provides controls and buffers for one or two additional 1403-2, 1403-3, or 2201-3 Printers in any combination.

Model 4 controls and buffers one IBM 1402 Card Read Punch Model N1 plus one 1404-2 Printer.

IBM 1443 Printer Model N1

The IBM 1443 Printer Model N1 (Figure 10) prints from 200 to 600 (maximum) lines per minute, depending on the number of characters in the set being used:

13-character set — 600 lines per minute
39-character set — 300 lines per minute
52-character set — 240 lines per minute
63-character set — 200 lines per minute

The standard printed line is 120 characters long, spaced horizontally at 10 characters to the inch. An additional 24 printing positions are available as an optional feature, raising the total to 144 possible printing positions.

All characters of the print set are on a single type-bar that moves back and forth horizontally across the paper. The bar is so made that each different character successively passes each print position. Printing takes place when the character to be printed corresponds with the character read from the printer's self-contained storage buffer.

A tape-controlled carriage, working under program control, advances paper and provides the vertical print formats. Vertical line spacing is adjustable at 6 or 8 lines per inch.

The printer contains its own control circuits and storage buffer; thus, all non-print functions can be carried on while the buffer is being loaded with a new line of characters to be printed. The 1443 is typically attached to the multiplexor channel, but may be attached to a selector channel.

IBM 1445 Printer Model N1

The IBM 1445 Printer Model N1 can print American Banking Association approved type font E-13B characters in magnetic ink, as well as conventional type characters, on the same document in one pass through the printer. When desired, the magnetic ink ribbon can be replaced with a standard ribbon for conventional printing in non-magnetic ink. All characters are printed eight to the inch, with a print span of 113 positions. Vertical spacing can be adjusted for either 6 or 8 lines per inch.

The standard type bar for the 1445 contains 56 characters: 14 E-13B characters, and 42 alphameric and special characters. Printing speed is from 190 to 525

lines per minute, depending on the number of characters in the set being used:

14-character standard numeric type bar	525 lines per minute
42-character alphanumeric character bar	240 lines per minute
56-character standard type bar	190 lines per minute

The 1445 is practically the same in appearance as the

1443 printer shown in Figure 10. Operation of the type bar and tape-controlled carriage is as described for the 1443. Like the 1443, the 1445 contains its own control circuits and storage buffer; thus, all non-print functions can be carried on while the buffer is being loaded with a new line of characters to be printed. The 1445 is typically attached to the multiplexor channel, but may be attached to a selector channel.

Magnetic Ink

IBM 1412 Magnetic Character Reader Model 1 and IBM 1419 Magnetic Character Reader Model 1

An IBM 1412 or 1419 Magnetic Character Reader can be attached directly to a System/360 channel for the fast and direct reading into the system of the magnetically-inscribed information on checks and other banking transactions. The 1412 and 1419 differ mainly in document-reading rates: the 1412 reads up to 950 documents per minute; the 1419 (Figure 22) as many as 1,600 documents per minute. As the documents are read, they may be sorted into as many as 13 classifica-



Figure 22. IBM 1419 Magnetic Character Reader

tions. All magnetic inscriptions can be validity-checked.

The documents read may be of intermixed size and thickness, as typically encountered in check-handling operations. The standard minimum length is 6 inches; shorter documents may be read at appreciably higher rates, but these are not sorted unless a special feature for that purpose is installed. Many other special features are available, including an endorser to print the bank's endorsement on the back of documents as they pass through the machine.

The magnetic character readers are normally attached to the multiplexor channel and operate in the multiplex mode.

IBM 1418 Optical Character Reader Model 1, 2, 3 and IBM 1428 Alphameric Optical Reader Model 1, 2, 3

Data printed on card or paper documents can be read optically into core storage with either the IBM 1418 Optical Character Reader (Figure 23) or the IBM 1428 Alphameric Optical Reader (Figure 24). The 1418 and 1428 differ functionally in that the 1418 reads numeric-only data, whereas the 1428 reads alphameric data.

Model 1 of either machine has three stackers and can select the documents according to class or general category; Model 2, with thirteen stackers, in addition to sorting by class, can sort each document numerically. Model 3, which is similar in appearance and opera-

tion to the Model 1, has a broader range of document-handling capabilities. Model 3 is particularly adaptable to cash-accounting applications in which a small stub is customarily returned with a payment.

In many instances, because of its ability to read information directly from a document, the 1418 or 1428 eliminates transcribing source data for entry into the system. This allows all functions necessary for processing data, from the source document to the final report, to be performed in one operation.

A mark-reading special feature permits reading prescribed pen or pencil marks directly into the system.

IBM 1231 Optical Mark Page Reader Model N1

The IBM 1231 Optical Mark Page Reader Model N1 (Figure 25) can be attached to a System/360 for direct reading of marks made by an ordinary lead pencil in specified positions (like the marks made for electronic test scoring) on 8½ by 11-inch sheets of paper.

The sheets can be read at a maximum rate of 2,000 per hour, or one each 1.8 seconds. The 1231 is normally attached to the multiplexor channel and operation is in the multiplex mode.

Applications for the 1231 are in payroll, order entry, accounts payable, inventory control, sales analysis, general ledger work, and many others in business, government, and institutions.

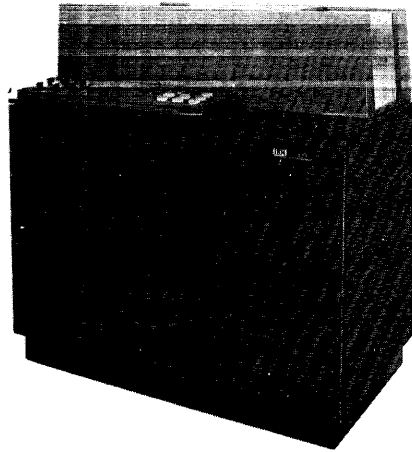

Figure 25. IBM 1231 Optical Mark Page Reader

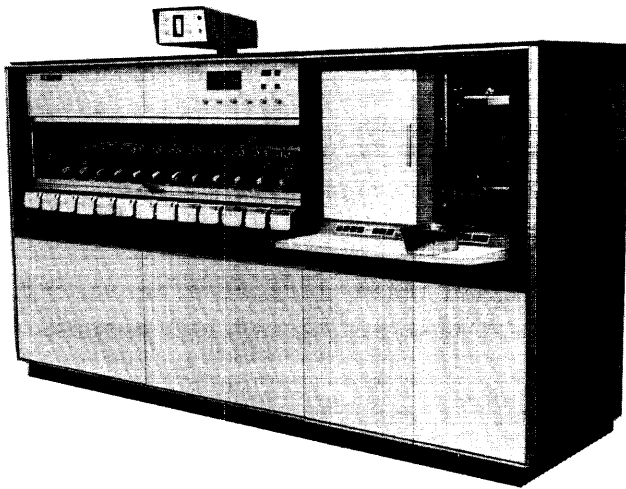

Figure 23. IBM 1418 Optical Character Reader

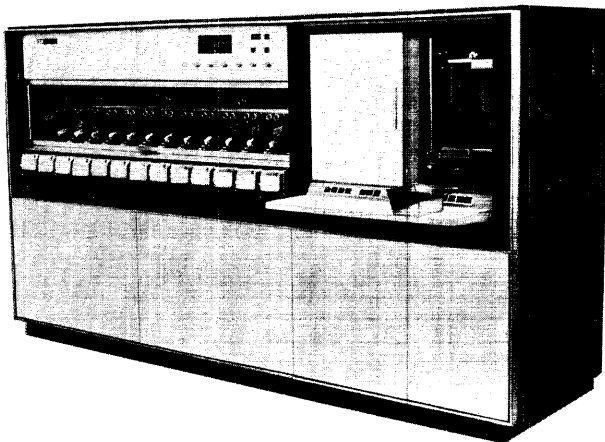

Figure 24. IBM 1428 Alphameric Optical Reader

Communications

Communication lines and data devices can be attached directly to the system channel via a control unit that performs character assembly and transmission control. The control unit may be either the IBM 2701 Data Adapter Unit or the IBM 2702 Transmission Control. The 2701 is a one- to four-line device that serves data communications, control, and data acquisition functions. The 2702 is a multi-line data communications device.

Other communications devices are the IBM 7770 and 7772 Audio Response Units, which provide vocal responses to telephoned inquiries. Furthermore, the 2701 and 2702 can serve as the intermedia to connect entire IBM communications systems, such as the IBM 1050 Data Communication System or the IBM 1070 Process Communication System.

IBM 2701 Data Adapter Unit

The IBM 2701 Data Adapter Unit (Figure 26) greatly expands the input/output capabilities of the IBM System/360. The 2701 provides direct connection of a variety of remote and local external devices to an IBM System/360. These devices include the IBM 1030 Data Collection System, the IBM 1050 Data Communication System, IBM 1060 Data Communication System, IBM 1070 Process Communication System, tele-



Figure 26. IBM 2701 Data Adapter Unit

graph terminals, telemetry terminals, and control and data acquisition equipment.

The IBM 2701 can be attached to either a selector channel or the multiplexor channel of the IBM System/360. Up to a maximum of eight 2701's can be attached to one IBM System/360 channel. Various adapters of the 2701 provide the necessary bit-byte conversions, interface terminations and controls for attachment of the specified terminal device. Various features are also available for further refinement in meeting system requirements.

The 2701 Data Adapter Unit has its own cabinet and power supplies, and it also provides for the housing of the associated transmission adapter. Together, the data adapter unit and a transmission adapter provide a single simplex (one way) or half-duplex (two ways alternately) data path, depending on the particular transmission adapter used, between external device(s) and an IBM System/360. Only one transmission adapter can operate with a data adapter unit. However, in some cases, additional adapters can be accommodated; this is done through the 2701's expansion feature. There are various types and combinations of adapters and features which are available in one 2701 Data Adapter Unit. These possible combinations are given in the "Configurations" section. The additional adapters may be connected to the same channel, or with the use of the second channel feature, to a second channel (See Figure 27).

In general, the maximum data rate capability of the 2701 is specified by the particular data adapter used, or it is limited by the channel capacity and the system configuration.

The IBM 2701 Data Adapter Unit consists of two functional sections: the transmission interface converter (xic) and the transmission adapter (xa).

The transmission interface converter, in all 2701's, is the same. The transmission adapter in one 2701 may or may not be the same as the transmission adapter in another 2701, depending on the adapter chosen.

Transmission Interface Converter

The transmission interface converter (xic) controls information transfer between a System/360 channel and a 2701's transmission adapter. The xic is attached to the selector and/or multiplexor channel, depending on the transmission adapter or adapters in the 2701. When connected to the selector channel, byte transfer is always in burst mode; when connected to the multiplexor channel, byte transfer is normally in the multiplex mode. However, in multiplexor channel operation the xic can force the operation to be in burst mode or provide for the transmission adapter to force a burst for any number of bytes (1 to 18)

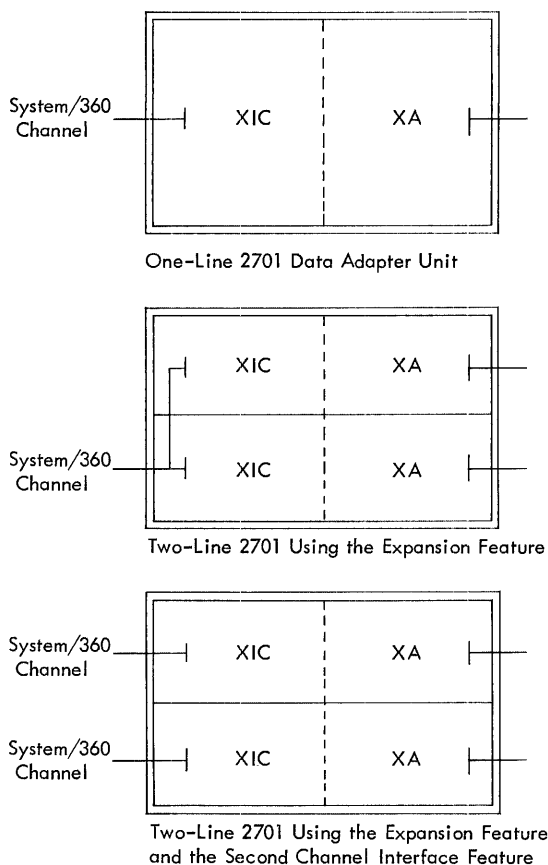

Figure 27. Use of the Expansion Feature and the Second Channel Interface Feature

Transmission Adapter

The transmission adapter (XA) provides for the connection of remote and local devices to the 2701 as well as the necessary controls to move data to or from the processing unit via the XIC. A number of data adapters are available to allow attachment of various remote devices through their communication facility as well as the attachment of various local devices.

Adapters

IBM Terminal Adapter Type I enables the 2701 to control data transfer between an IBM System/360 and the following terminals:

IBM 1050 Data Communication System can attach to the 2701 with the selective speed of 134.4 bits per second via common carrier switched 150 bits per second teletypewriter exchange (TWX) network using Western Electric Data Set 103A or equivalent, common carrier leased private line telephone service using Western Electric Data Set 103F or equivalent, or Western Union Class D (180 bits per second) Channels (Western Union Data Set 8500), or privately owned communications network conforming to *IBM 1030 Data Collection System Physical Planning*, Form A24-3021.

IBM 1060 Data Communication System can attach to the 2701 with selective speed of 134.4 bits per second via common carrier leased private line telephone service using Western Electric Data Set 103F or equivalent, or Western Union Class D (180 bits per second) Channels using Western Union Data Set 8500, or privately owned communication networks conforming to *IBM 1030 Data Collection System Physical Planning*, Form A24-3021.

IBM 1070 Process Communication System with the following selective speeds:

134 – via common carrier leased private line telephone service using Western Electric Data Set 103F or equivalent, or Western Union Class D (180 bits per second) Channels using Western Union Data Set 8500 or privately owned communications networks conforming to IBM SRL Manual *1030 Data Collection System, Physical Planning*, Form A24-3021.

600.0 – via common carrier, 4 wire, full duplex leased private telephone service using Western Electric Data Set 202B or equivalent or Western Union Class E (1200 bits per second) Channels using Western Union Data Set 8501.

IBM Terminal Adapter Type II provides the 2701 with the controls for operation with the 1030 Data Collection System at 600 bits per second via common carrier 4-wire full-duplex leased private line telephone service using Western Electric Data Set 202B or equivalent, or Western Union Class E (1200 bits per second) Channels using Western Union Data Set 8501, or via privately owned communication networks conforming to *IBM 1030 Data Collection System Physical Planning*, Form A24-3021.

IBM Telegraph Adapter enables the 2701 to control data transfers between an IBM System/360 and the 1050 Data Communication System operating at 75 bits per second via Telephone Company Schedule 3 or Western Union Class C Channels.

Telegraph Adapter Type I enables the 2701 to control data transfer between an IBM System/360 and the AT&T 83B2 or Western Union Plan 115A terminal at one of the following selective speeds:

First selective speed provides operation over Telephone Company Schedule 1 Channels at 45.5 bits per second.

Second selective speed provides operation over Telephone Company Schedule 2 Channels or Western Union Class B Channels at 56.89 bits per second.

Third selective speed provides operation over Telephone Company Schedule 3 Channels or Western Union Class C Channels at 74.2 bits per second.

Telegraph Adapter Type II provides the 2701 with controls for operation with Teletype Models 33 and/or 35 terminals at 110 bits per second on the common carrier switched teletypewriter exchange (TWX) network using Western Electric Data Set 103A or equivalent.

World Trade Telegraph Adapter enables the 2701 to control data transfer between the IBM System/360 and various European telegraph printers over selectively single current or double current telegraph lines.

Serial Synchronous Adapter enables the 2701 to control data transfers between an IBM System/360 and a serial synchronous data channel via one of the following selective features:

Western Electric Data Set 301B or equivalent operating at 40.8 kilobaud over common carrier broadband communications service; or telemetry bit reconstructor and bit synchronizers with a maximum data rate of 2 megabaud.

Sync Pattern Feature (prerequisite: serial synchronous adapter) provides machine detection of any one sync pattern up to 32 bits maximum. The pattern must not be more than 4,096 bits apart.

Parallel Data Adapter enables the 2701 to control data transfers between the IBM System/360 and a 16-bit wide parallel data path for up to eight customer devices (only one customer device operating at a time). The data path may be expanded to a maximum of 48 data bits.

Parallel Data Extension Feature (prerequisite: parallel data adapter) provides additional eight bit extension to the customer's parallel data interface. Up to a maximum of four of these extensions can be added to each parallel data adapter.

Parallel Data Time Out Feature (prerequisite: parallel data adapter) provides a two-second time out of the external device response to a data transfer request.

Contact Sense Adapter, under System/360 control, provides a rapid means of transferring the status of up to 48 contacts or binary voltages to the System/360. An extension feature allows the number of contacts or binary voltages sensed to be increased to 144.

Contact Sense Extension Feature (prerequisite: contact sense adapter) provides an additional 48 data bit extension to the customer's contact sense interface.

Contact Sense Second Extension Feature (prerequisite: contact sense adapter with contact sense extension feature) provides a second 48 data bit extension.

Contact Operate Adapter provides 48 contacts, operated under System/360 control for customer usage. The number of contacts operated can be expanded to 144.

Contact Operate Extension Feature (prerequisite: contact operate adapter) provides for an additional 48 data bit extension to the customer's contact operate interface. A maximum of two contact operate extension features are permissible per contact operate adapter.

Features

Expansion Feature provides the 2701 with the capability of adding an additional adapter. Each such adapter, after the first, requires an expansion feature. See Figure 27. The maximum number of expansion features is three unless otherwise limited by the configuration. (See "Configurations.")

Expansion Capability Feature provides for the connection of additional expansion features and the second channel interface feature. See "Configurations."

Second Channel Interface Feature (prerequisites: expansion capability feature and expansion feature) provides a separate channel interface for the second adapter in the expanded 2701. See Figure 27. Maximum of one per 2701. The use of this feature may be prevented by the system's configuration. (see "Configurations" following).

Automatic Call Feature (prerequisite: either IBM

terminal adapter type I or telegraph adapter type II) provides the IBM System/360 with the capability of dialing a remote terminal. The common carrier switched telephone, or 150 bits per second teletypewriter exchange (TWX) networks using a common carrier automatic calling unit, Western Electric 801 A or equivalent.

IBM Line Adapter Feature (prerequisite: either the IBM terminal adapter type I or the IBM terminal adapter type II) provides for the attachment to customer owned private telephone lines for distances up to 8 wire-miles conforming to IBM SRL manual, *1030 Data Collection System, Physical Planning*, Form A24-3021.

Configurations

The 2701 has the following basic adapters:

1. One parallel data adapter when the third or fourth parallel data extension feature is required.
2. One to two parallel data adapters when neither requires the third or fourth parallel data extension feature.
3. One contact sense adapter.
4. One contact operate adapter.
5. One serial synchronous adapter.
6. One to two of the following start/stop communications adapters:

IBM Terminal Adapter Type I
IBM Terminal Adapter Type II
IBM Telegraph Adapter
Telegraph Adapter Type I
Telegraph Adapter Type II
World Trade (wr) Adapter

Any combination of two adapters may be ordered for one 2701. Each adapter, after the first, requires an expansion feature. The second adapter requires the expansion capability feature. Examples of some of the possible maximum configurations are given below:

- Four start/ stop adapters.
- Four parallel data adapters where all are 32 bits or less.
- Three parallel data adapters where only one requires more than 32 bits.
- Two parallel data adapters where both require more than 32 bits.
- Two parallel data adapters each requiring less than 32 bits and two start/stop adapters.
- One contact sense and one contact operate adapter.

The following features modify the above:

Automatic Call Feature (the first ordered) replaces one of the start/stop adapters; additional automatic call features do not. This allows a maximum of three start/stop adapters in one 2701. With two additional automatic call features, all three may dial.

Second Channel Interface Feature requires the expansion capability feature and is not available with the following combinations of adapters itemized above.

- Adapters 1 and 3
- Adapters 1 and 4
- Adapters 3 and 3
- Adapters 3 and 4
- Adapters 4 and 4

IBM 2702 Transmission Control

The IBM 2702 Transmission Control (Figure 28) enables System/360 users to combine data processing and data communications within the same system configuration. The 2702 directs and controls information flow between the system and a variety of remote communications terminals; the link with the remote terminals is via private and common carrier transmission facilities. Data communication equipment that can be connected to the 2702 includes:

- IBM 1030 Data Collection System
- IBM 1050 Data Communication System
- IBM 1060 Data Communication System
- IBM 1070 Process Communication System
- AT&T 83B2 Selective Calling Stations
- Western Union Plan 115A Outstations
- Model 33/35 Teletypewriter Terminals

Up to eight 2702 units can be attached to the multiplexor channel, and operation of each is in the multiplex mode.

The 2702 is modular and flexible in line capacity, transmission code, and speed. The basic 2702 can have up to 15 half-duplex lines and operate at speeds up to 180 bits per second for any or all attached communication lines. An increase of either the line speed or the number of lines can be made by adding optional features.

The 2702 operates in a start-stop mode at transmission rates up to 600 bits per second. On input, the 2702 accepts electrical signals sequentially from a number of communications lines, converts these signals into characters, and transfers the characters (bytes)

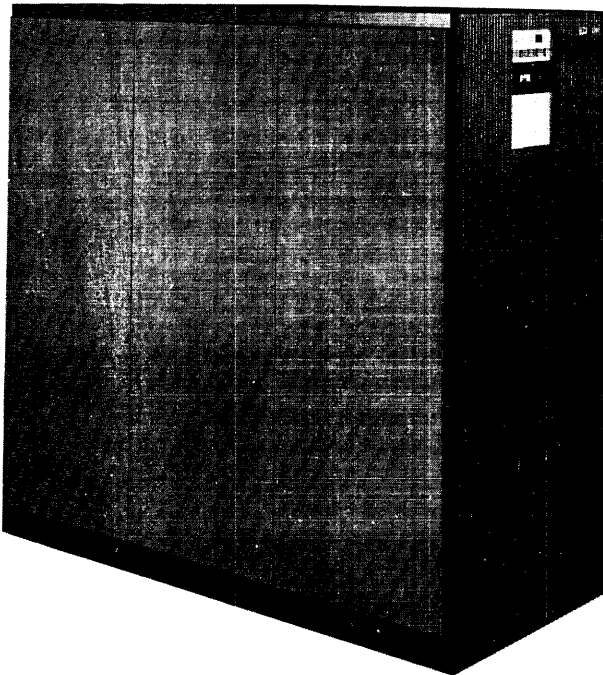

Figure 28. IBM 2702 Transmission Control

to the System/360. On output, the 2702 transfers (serially by bit) characters from the System/360 to the remote terminal. One 8-bit buffer per line is provided for multiplex operation on the multiplexor channel. On both input and output, any message buffering is done by the processing unit; the 2702 itself does not impose restrictions on message length. All necessary bit-byte conversions, data control, and matching to common carrier equipment are accomplished by the 2702.

Functionally, the 2702 consists of the interface control section, the storage and common control section, the terminal controls section, and the line adapter section.

Interface Controls

The interface control section provides the facilities for connecting the 2702 to the standard interface used by the System/360.

Storage and Common Controls

This section accepts commands and data bytes from the interface controls section and common functions such as character assembly and buffering, line timeout, and error control.

Terminal Controls

This section contains circuits necessary to perform functions associated with a given communications terminal. The terminal control regulates the operation with the attached terminal, performing such functions as character or character sequence recognition and checking of the transmission code. One terminal control may service all of the terminals of the same type. The following terminal controls can be selected for the 2702. At least one, and no more than three, terminal controls can be chosen for any 2702 Transmission Control.

IBM Terminal Control Type I enables the 2702 to operate with the IBM 1050 Data Communication System, the IBM 1060 Data Communication System, or the IBM 1070 Process Communication System.

Telegraph Terminal Control Type I enables the 2702 to operate with the AT&T 83B2 Selective Calling Stations or the Western Union Plan 115A Outstations.

Telegraph Terminal Control Type II enables the 2702 to operate with Model 33 or 35 teletypewriter terminals.

IBM Terminal Control Type II enables the 2702 to operate with the IBM 1030 Data Collection System.

World Trade Telegraph Terminal Control enables the 2702 to operate with various European telegraph printers over either single current or double current telegraph lines.

Line Adapters

This section contains adapters, one for each communication line attached to the 2702. Three types of adap-

ters are available for operation with the 2702; the choice is generally independent of the type of terminals and dependent on the communications facility specified:

Data Set Line Adapter: For leased or private connections and/or for connections via the dial network.

Telegraph Line Adapter: For communications facilities requiring 60 milliamperes neutral signaling.

IBM Line Adapter: For customer-owned connections to IBM terminals.

2702 Special Features

IBM Terminal Control Base is required to attach IBM terminal controls.

IBM Terminal Control Type I provides the 2702 with the controls to operate with the IBM 1050 and 1060 Data Communication Systems or the IBM 1070 Process Communication System.

The IBM 1050 Data Communication System may attach to the 2702 with the following selective speeds:

75.0 bits per second — via Telephone Company Schedule 3 or Western Union Class C Channels.

134.4 bits per second — via common carrier switched telephone network or common carrier switched 150 bits per second teletypewriter exchange (TWX) network (Western Electric Data Set 103A or equivalent), via common carrier leased private line telephone service using Western Electric Data Set 103F or equivalent or Western Union Class D (180 bits per second) Channels (Western Union Data Set 8500), or via privately owned communication networks conforming to *IBM 1030 Data Collection System Physical Planning*, Form A24-3021.

The IBM 1060 Data Communication System may attach to the 2702 at the selective speed of 134.4 bits per second over the following facilities:

Common carrier leased private line telephone service using Western Electric Data Set 103F or equivalent or Western Union Class D (180 bits per second) Channels using Western Union Data Set 8500 or via privately owned communication networks conforming to *IBM 1030 Data Collection System Physical Planning*, Form A24-3021.

The IBM 1070 Process Communication System may attach to the 2702 with the following selective speeds:

134.4 bits per second — via common carrier leased private line telephone service using Western Electric Data Set 103F or equivalent, or Western Union Class D (180 bits per second) Channels (Western Union Data Set 8500), or privately owned communication networks conforming to *IBM 1030 Data Collection System, Physical Planning*, Form A24-3021.

600.0 bits per second — via common carrier, 4 wire, full duplex leased private line telephone service using Western Electric Data Set 202B or equivalent or Western Union Class E (1200 bits per second) Channels (Western Union Data Set 8501).

IBM Terminal Control Type II provides the 2702 with the controls for operation with the 1030 Data Collection System at 600 bits per second via common carrier 4-wire full-duplex leased private line

telephone service using Western Electric Data Set 202B or equivalent or Western Union Class E (1200 bits per second) Channels using Western Union Data Set 8501 or via privately owned communication networks conforming to *IBM 1030 Data Collection System Physical Planning*, Form A24-3021.

Telegraph Terminal Control Base is required for the attachment of telegraph terminal controls.

Telegraph Terminal Type I provides the 2702 with the controls to operate with the AT&T 83B2 or Western Union Plan 115A Terminals.

First selective speed provides operation over Telephone Company Schedule 1 Channels at 45.5 bits per second.

Second selective speed provides operation over Telephone Company Schedule 2 Channels or Western Union Class B channels at 56.89 bits per second.

Third selective speed provides operation over Telephone Company Schedule 3 channels or Western Union Class C channels at 74.2 bits per second.

Telegraph Terminal Control Type II provides the 2702 with controls for operation with Teletypewriter Model 33 and/or 35 terminals at 110 bits per second on the common carrier switched 150 bits per second teletypewriter exchange (rwx) network using Western Electric Data Set 103A or equivalent.

Data Set Line Adapter provides for the attachment of terminals via private leased line facilities using the Western Electric Data Set 103F or equivalent, the Western Union Data Set 8500, the IBM 3976 and 3977 Modems or equivalent; or, for attachment over the common carrier switched telephone network via the Western Electric Data Set 103A, or equivalent.

Telegraph Line Adapter provides for attachment to common carrier leased private line telegraph service.

IBM Line Adapter provides for the attachment to customer owned private telephone lines for distance of up to 8 wire-miles conforming to *IBM 1030 Data Collection System Physical Planning*, Form A24-3021.

Speed Extension Feature increases the line speed capability to 600 bits per second on all 15 lines of the basic 2702.

31 Line Expansion Feature increases the line attachment capacity of the 2702 to 31 half-duplex communications lines at operating speeds up to 200 bits per second.

Automatic Call Feature provides the 2702 with automatic dialing capabilities on the common carrier switched telephone or 150 bits per second teletypewriter (rwx) network for eight line attachments.

Automatic Call Expansion Feature (prerequisite: automatic call feature) expands the automatic dialing

capabilities of the automatic call feature to 16 line attachments.

Automatic Call Adapter (prerequisite: automatic call feature) provides for attachment of a common carrier automatic calling unit (Western Electric 801A or equivalent).

Two Processor Switch provides for switching the 2702 between the multiplexor channels of two IBM System/360 processing units.

Communications Systems

IBM 1030 Data Collection System

The IBM 1030 Data Collection System (Figure 29) collects data from remote locations and communicates, at 60 characters per second, with the System/360 via either the IBM 2701 Data Adapter Unit or the IBM 2702 Transmission Control. The 1030 thus provides full on-line inquiry and reply facilities to and from the processing unit, such as between plants or within a plant.

A 1030 system includes IBM 1031 Input Stations and IBM 1033 Printers at locations remote from the computer area. Each IBM 1031 Input Station accepts pre-punched cards and badges, and also variable-length numeric data, through either a 12-column manual entry unit or a 12-column data cartridge. Each IBM 1033 Printer provides print-out replies. Each 1030 line can have as many as 24 inquiry stations and 24 printers.

IBM 1050 Data Communication System

The IBM 1050 Data Communication System (Figure 30) is a multipurpose office-oriented TELE-PROCESSING® system. It can be operated over leased communications lines (through the IBM 2701 Data Adapter Unit or 2702 Transmission Control) to connect the System/360 Model 30 to remote locations. Transmission is half-duplex (two ways alternately) between the 1050's central terminal and the remote terminal.

The versatility of the 1050 system is furthered by its variety of configurations. The choice of configura-

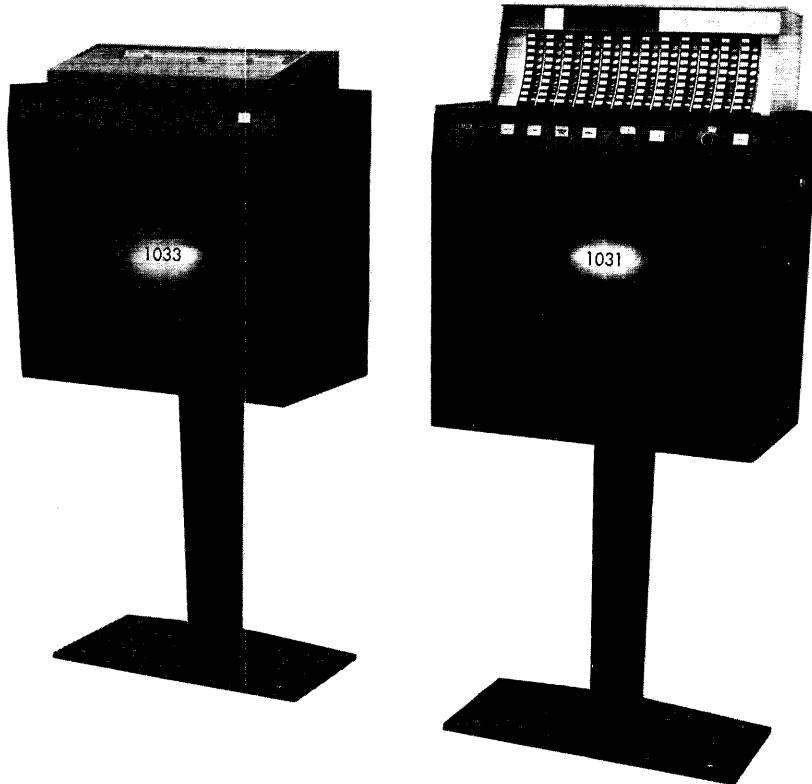

Figure 29. IBM 1030 Data Collection System

tions ranges from a receiver-printer to a configuration that includes:

- Manual keyboard entry
- Printed page output
- Punched-card input and output
- Paper-tape input and output
- Edge-punched-document input and output

The component type numbers and names are:

- 1051 Control Unit
- 1052 Printer-Keyboards
- 1053 Printer
- 1054 Paper Tape Reader
- 1055 Paper Tape Punch
- 1056 Card Reader
- 1057 Card Punch
- 1058 Printing Card Punch

In addition to providing on-line data transmission at 14.8 characters per second, the 1050 can also simultaneously prepare and record off-line data. Transmission is checked for accuracy.

The IBM 1051 Control Unit is required in all configurations and contains the power supply, code translator, data channels, and control circuitry for the 1050 system.

IBM 1060 Data Communication System

The IBM 1060 Data Communication System (Figure 31) improves customer services in such institutions as savings banks, savings and loan associations, and commercial banks. The 1060 links the teller-window locations, either within the main office of the institution or in branch offices, with the System/360 Model 30. The local 1060's are connected to the 2701 Data

Adapter Unit or 2702 Transmission Control by communication-company facilities or IBM line adapter.

The teller uses the keyboard on the 1060 to transmit transaction data to the system, via the 2701 or 2702, at a speed of 14.8 characters per second. The record of the account is updated by the computer, and the status of the account is transmitted back to the 1060. Here, the data are automatically posted on terminal-record tape and on the customer's account document (passbook). At the same time, the balance in the 1060 accumulator is adjusted to reflect the transaction on the teller's balance on hand.

Besides the reduction in required space and time, the 1060 also gives computer control over:

- Account number
- Passbook balance
- No-book transactions
- Dormant accounts
- Uncollected funds
- Hold conditions
- Interest

The 1060 is made up of:

IBM 1062 Teller Terminal with print unit, controls, keyboard and the program-tape unit used for controlling the 1060 off-line.

IBM 1061 Control Unit providing communication-line control and 1062 Teller Terminal control.

Special features for the 1060 include a line adapter feature that enables the 1060 to be installed in the same central office area as the processing unit, and an off-line feature for the 1062. An adding machine feature permits the use of the keyboard as an adding machine; this feature is included if the teller terminal has the capability of going off-line.

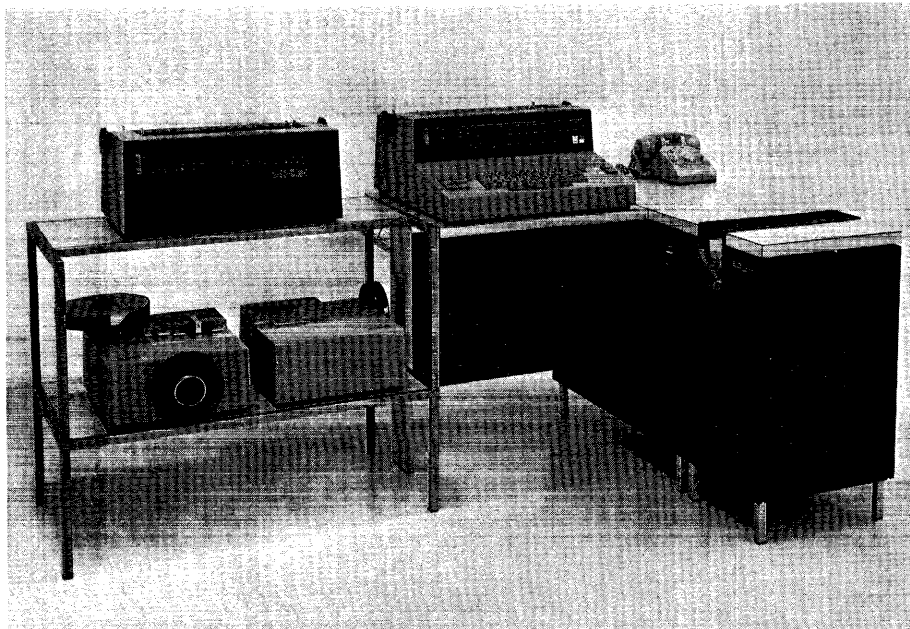

Figure 30. IBM 1050 Data Communication System

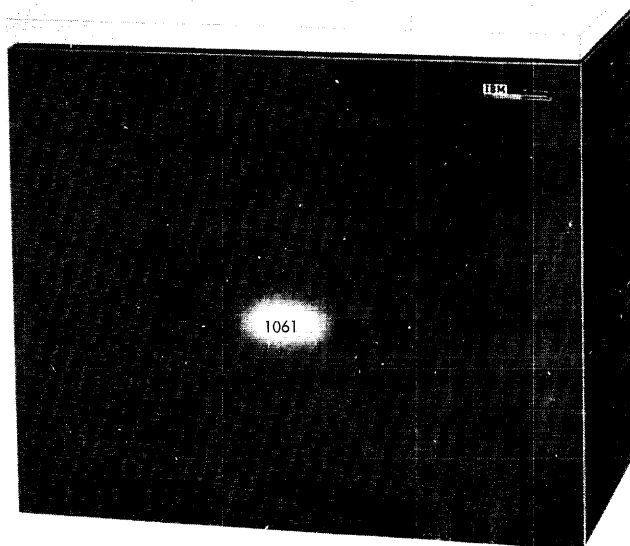
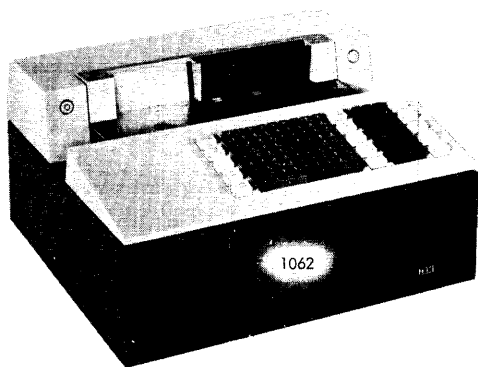

Figure 31. IBM 1060 Data Communication System

IBM 1070 Process Communication System

The IBM 1070 Process Communication System (Figure 32) is a TELE-PROCESSING terminal designed for on-line data transmission between remote process locations and a central IBM System/360. Connection to the System/360 is made by a 2701 Data Adapter Unit or 2702 Transmission Control.

The 1070 facilitates the System/360 control of natural gas and petroleum pipe lines, utility distribution systems, and the collection of process data in petroleum refineries, chemical plants, paper mills, iron and steel works, batch processes in manufacturing, and many other applications.

The 1070 system consists of the following units:

- 1071 Terminal Control Unit Model 1 (14.8 characters per second) or Model 2 (66.6 characters per second)
- 1072 Multiplexor and Terminal Units
- 1073 Terminal Units

- Process Operator Console Units
 - 1074 Binary Display
 - 1075 Decimal Display Model 1
 - 1076 Manual Binary Input
 - 1077 Manual Decimal Input
 - 1053 Output Printer

The 1070 controls up to 300 process input/output functions, including analog input, digital input, contact sense, contact operate, decimal output, and pulse output, as well as the process operator console units listed above. All the data transmission sequences to and from 1070 terminals are under the control of the IBM System/360.

Connecting the 1070 via the 2701 requires, on the 2701, the IBM Terminal Adapter Type I; via the 2702, the IBM Terminal Control Base, IBM Terminal Control Type I, and a selective speed of 134.49 bits per second for the 1071 Model 1 or 600 bits per second for the 1071 Model 2.

Audio Communications

IBM 7770 Audio Response Unit Model 3

The IBM 7770 Audio Response Unit Model 3 (Figure 33) provides recorded voice response to inquiries made from telephone type terminals and similar terminals such as the IBM 1001 Data Transmission Terminal. The 7770 is attached to the IBM System/360 via the multiplexor channel; it connects the computer to the telephone network.

The audio response is composed from a vocabulary pre-recorded in male or female voice (optionally) on a magnetic drum within the 7770. An inquiry consists of a series of digits from a terminal (usually a telephone). The 7770 passes these digits one by one to the processing unit, which processes the inquiry and sends the response message back, character by character, to the 7770. The message, consisting of a series of addresses, selects the appropriate words from the vocabulary on the magnetic drum, and transmits the vocal reply back to the inquirer.

Special Features

I/O Line Expander provides four additional input/output lines.

I/O Line Frame provides an additional frame when the number of input/output lines exceeds 16.

I/O Line Panel provides an additional line panel when the number of input/output lines exceeds eight.

Vocabulary/Words Expansion provides 16 additional words.

Vocabulary/Line Expansion is required on any 7770 when it has more than 16 input/output lines or more than 63 words.

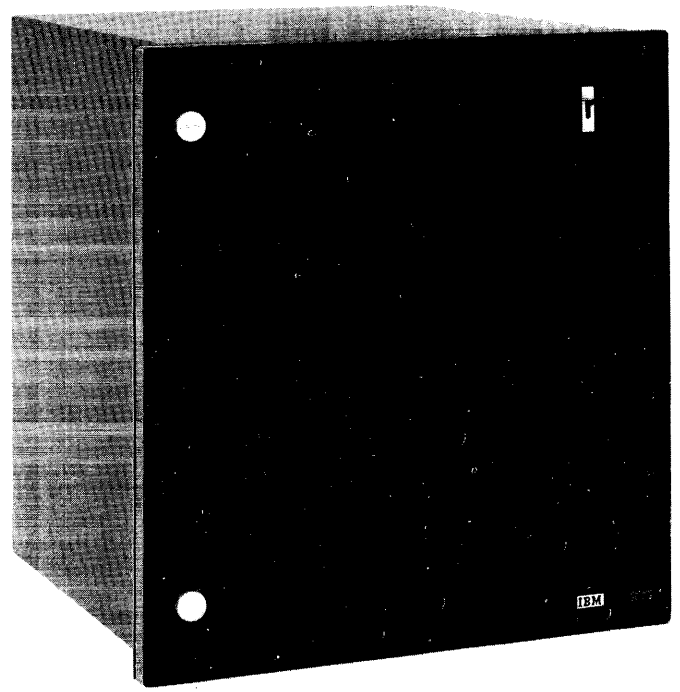
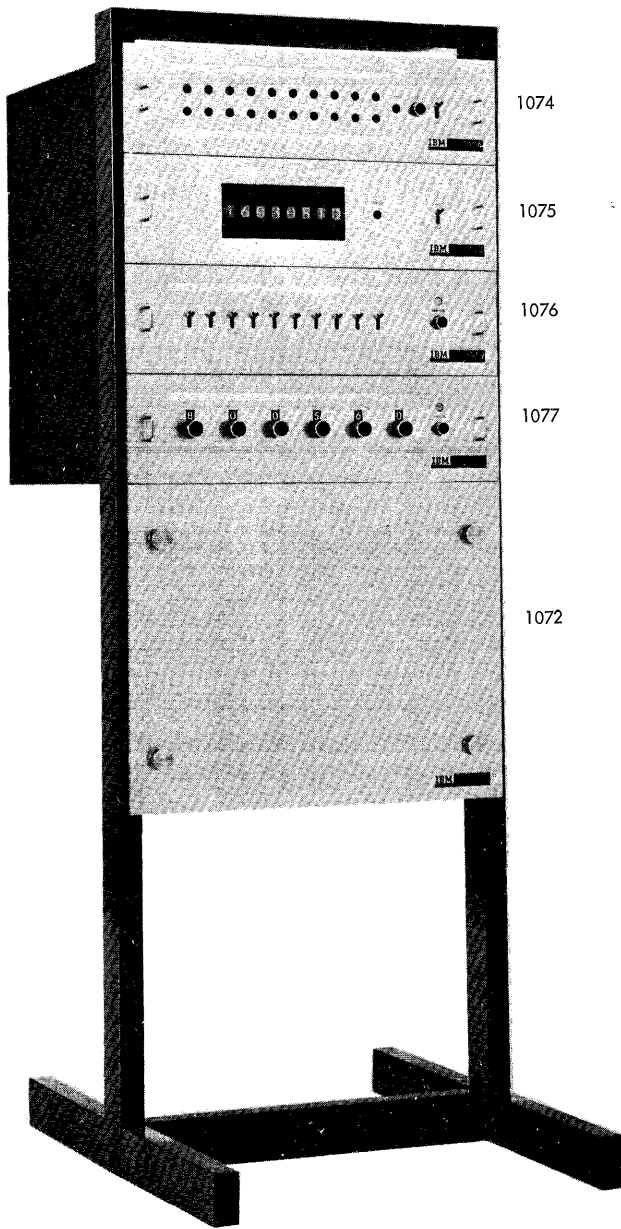

Figure 32. IBM 1070 Process Communication System

IBM 7772 Audio Response Unit Model 3

The IBM 7772 Audio Response Unit Model 3 (Figure 34) can be attached to the System/360 multiplexor channel, connecting the system to the telephone network in the same manner as the IBM 7770 Audio Response Unit Model 3. It provides a recorded voice response, optionally male or female, to inquiries made from telephone type terminals.

The main difference between the 7772 and 7770 is in the way their functions are performed:

7772 – Audio Response comes from a vocabulary pre-recorded in digitally coded voice on an external disk file.

7770 – Audio Response comes from a vocabulary pre-recorded in analog form on a magnetic drum within the 7770.

Instead of receiving a series of drum addresses

from the processing unit, the 7772 receives the digitally coded voice messages, which are converted to audio in the 7772.

Another major difference between the 7770 and 7772 can be summarized as follows: The 7770 offers a limited vocabulary with many lines (four lines basic, expandable with standard features to 16, or with special features to 48), whereas the 7772 offers unlimited vocabulary with a small number of lines (two lines basic, expandable with special features to a maximum of eight lines).

Special Features

I/O Line Expander provides two additional input/output lines to the 7772. No more than three i/o line expanders may be added.

I/O Line Frame provides an additional frame when the input/output lines exceed four.

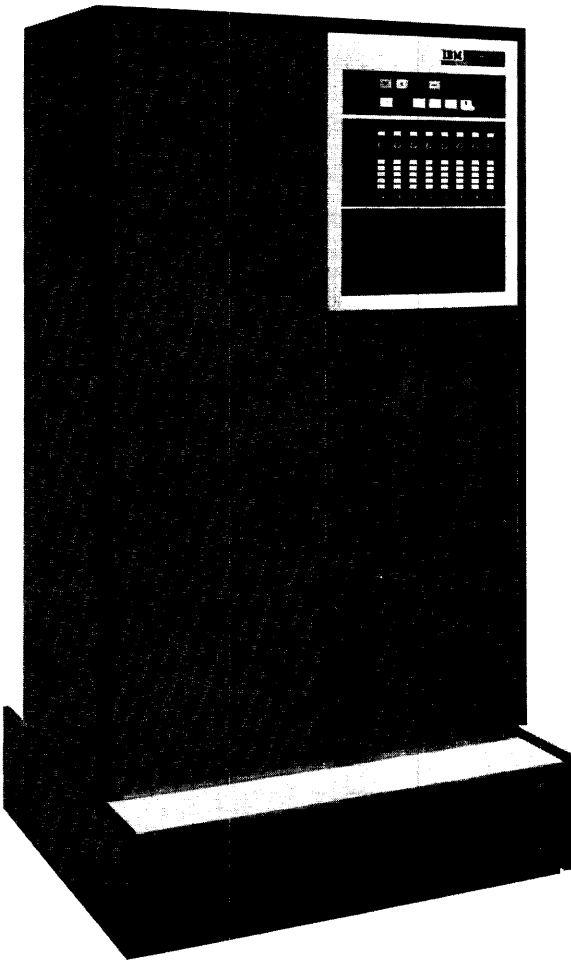

Figure 33. IBM 7770 Audio Response Unit

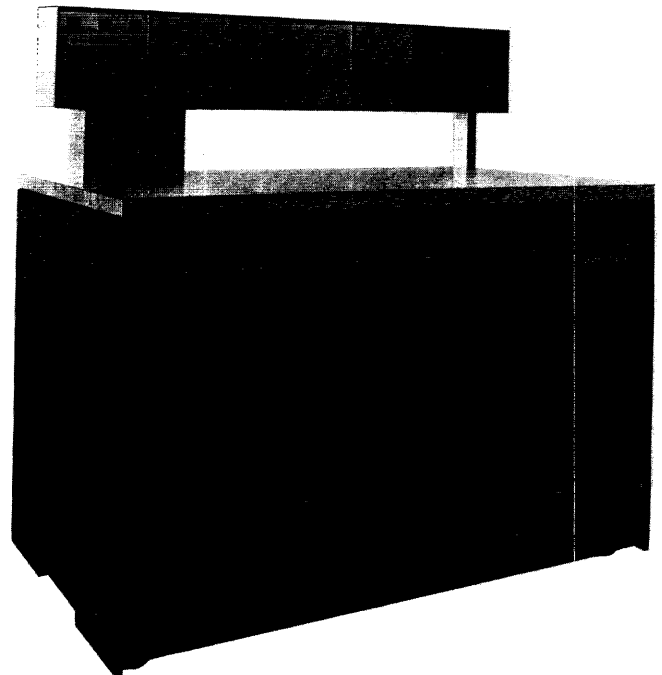

Figure 34. IBM 7772 Audio Response Unit



**International Business Machines Corporation
Data Processing Division
112 East Post Road, White Plains, N. Y. 10601**